

EuroRack - Midi IO - Board

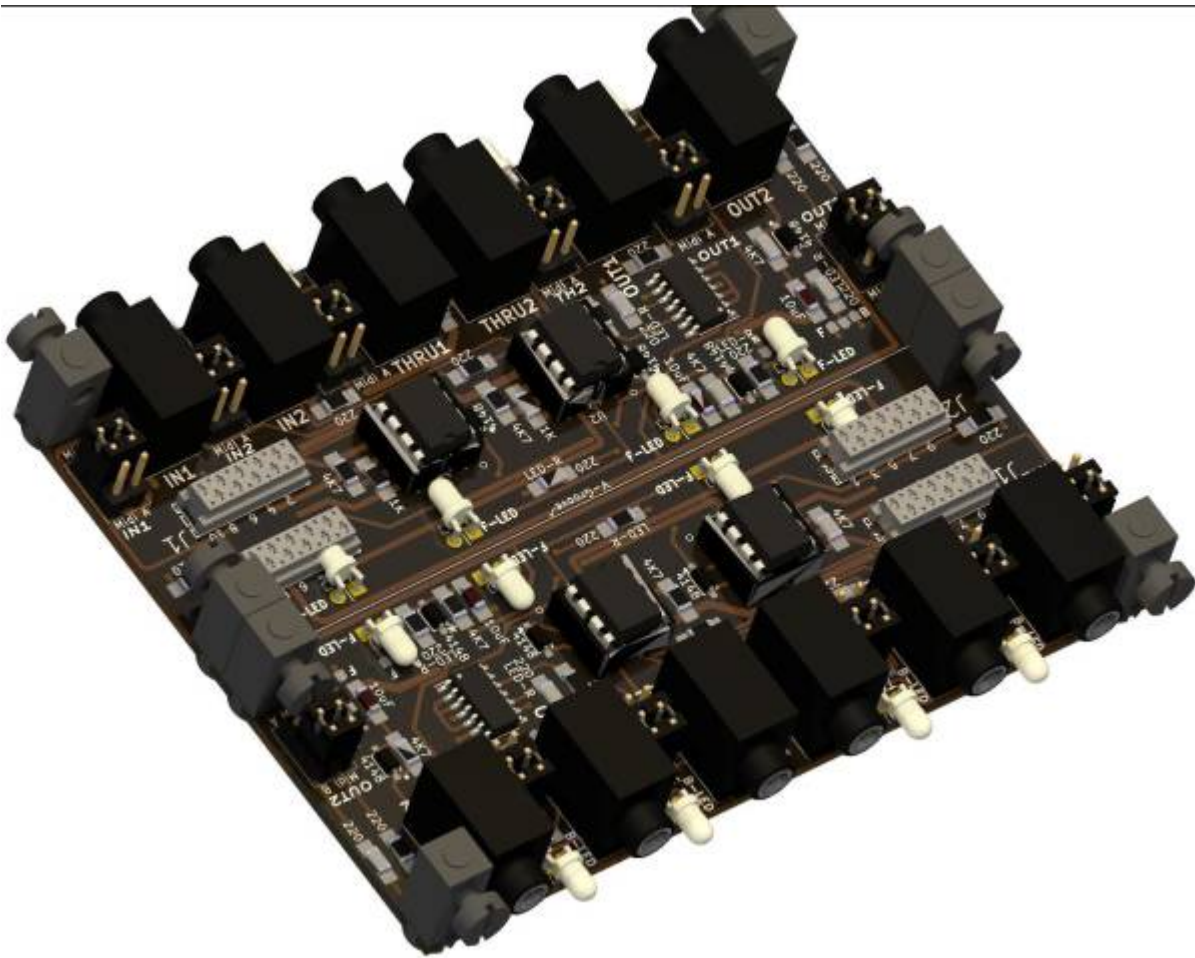

PCB Size is 100x40mm

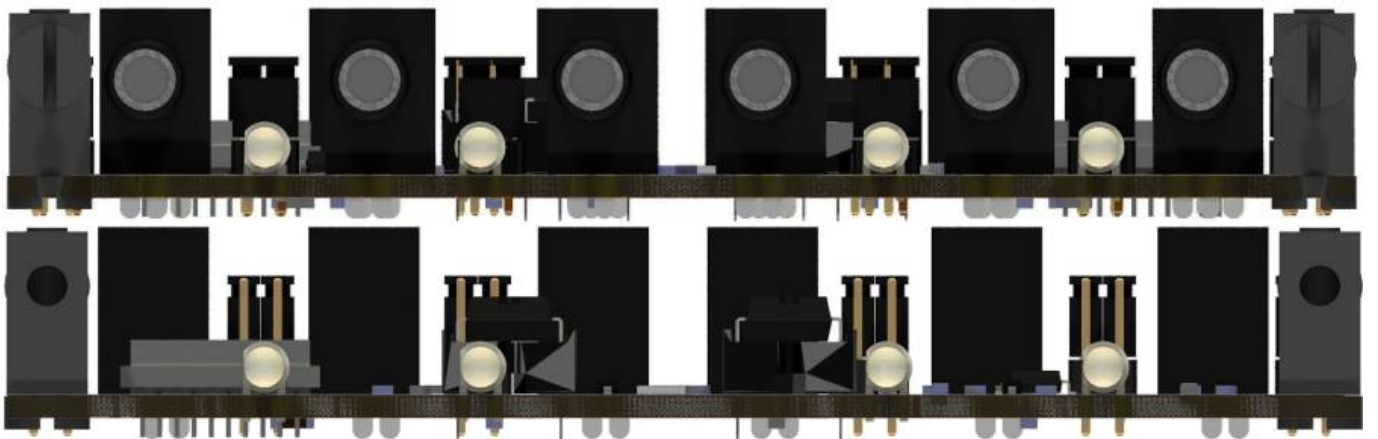

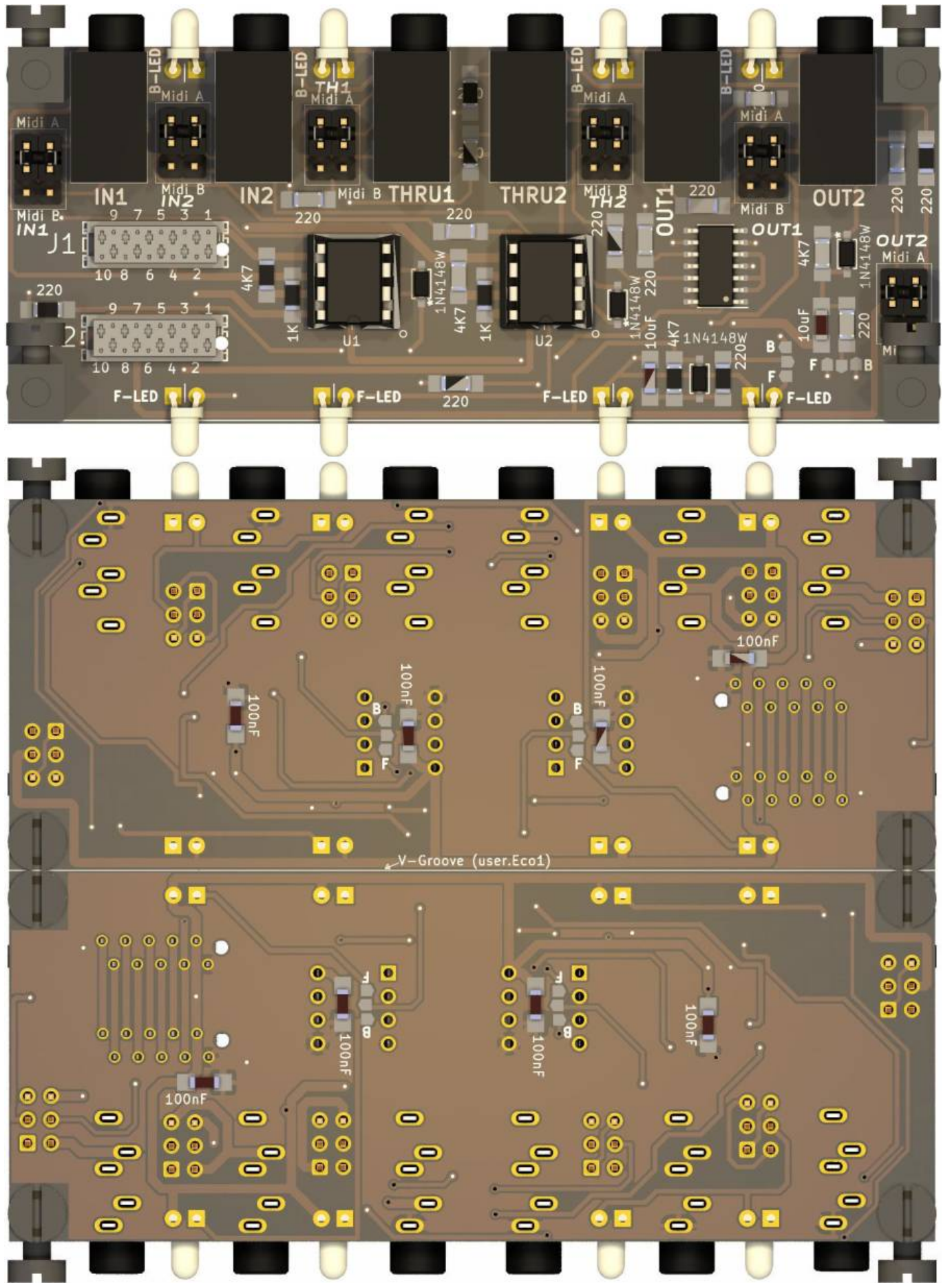

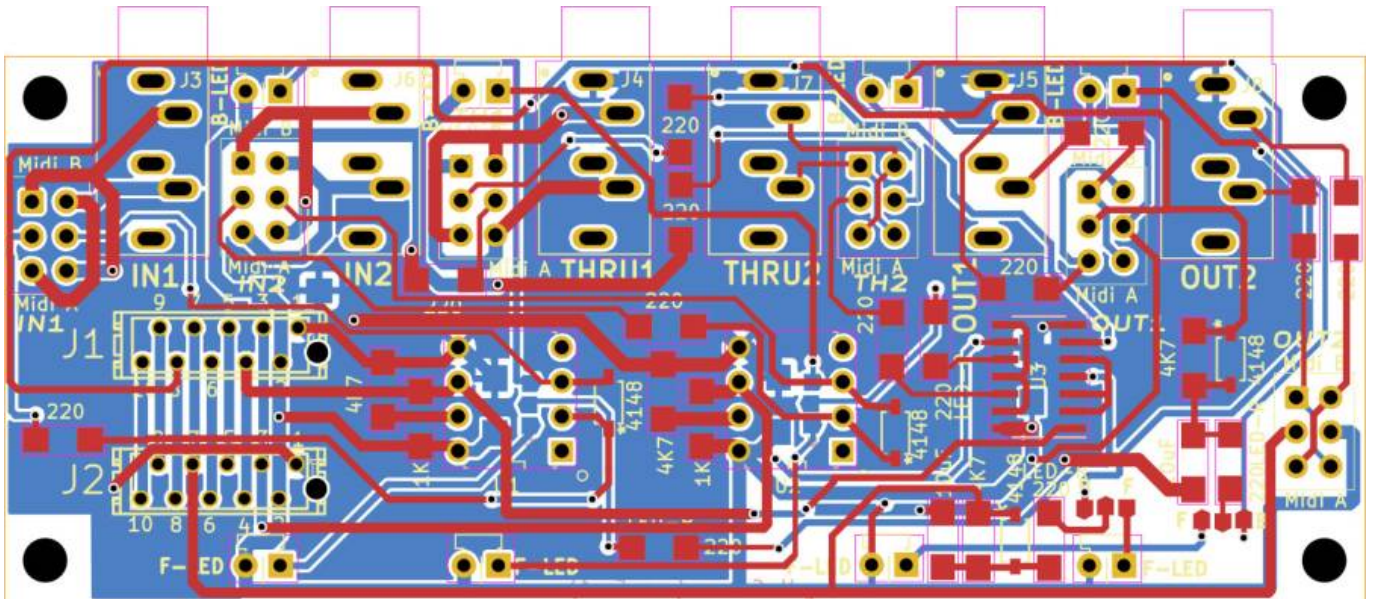
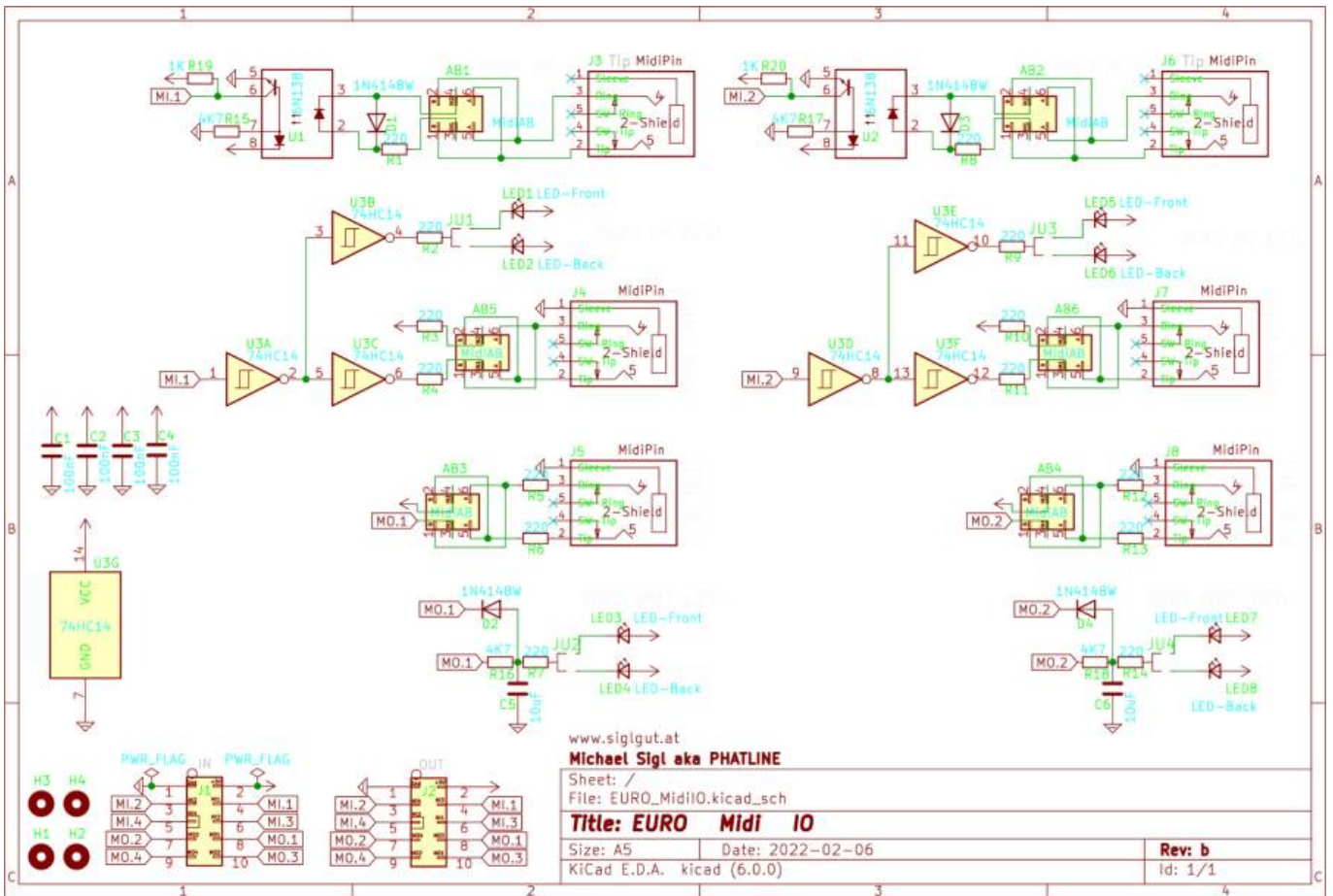

Hardware Requirements

- Soldering Iron - with a Dip that can Handle Thruhole-Parts and 1206 SMDs, solder Paste...
- The other Parts from the BOM
- a Midibox Core32

Building and BOM

All necessary Information is printed on the PCB, but also check the [Schematic](#)

Mouser:

Ref	Q	mouser	Type	Footprint	Description
AB1 - AB6	1	649-1012938192001BLF	2x20 Pin Header	2x3 Pin Header 2.54 * 2.54 Pitch	to set Midi A-B Standard
Jumper	12	571-8815451	JUMPER	Jumper	to set Midi A-B Standard
C1 - C4	4	187-CL31B104KBCNNND	100nF unolarized	1206 inch - 3216 metric	Unpolarized! > 10V
C5 - C6	2	963-TMK316AB7106KLHT	10uF unpolarized	1206 inch - 3216 metric	Unpolarized! > 10V
D1 - D4	4	241-1N4148W_R1_00001	1N4148W	SOD123-DIODE	doesnt draw much current
J1 - J2	2	571-12150790	TE Connectivity	2x5P Micromatch Female	To solder in the PCB
J1 - J2	4	571-1-2178712-0	TE Connectivity	2x5P Micromatch Male	Crimp Connector for Flat-Cables
J3 - J8	6	490-SJ1-3535NG	CUI 3.5mm Audio Jack	3.5mm Jack	those you know from PC-Mobos
LED1 - LED2	2	696-SSL-LX30FT4ID	LED ROT	LED_3mm	there are 8 LEDs you use only 4...
LED3 - LED4	2	696-SSL-LX30FT4GD	LED GRÜN	LED_3mm	... front or back soldered
R1 - R14	14	RC1206FR-07220RL	220	1206 inch - 3216 metric	5 10% doesnt matter
R15 - R18	4	CR1206-JW-472ELF	4K7	1206 inch - 3216 metric	5 10% doesnt matter
R19 - R20	2	AC1206FR-071KL	1K	1206 inch - 3216 metric	5 10% doesnt matter
U1 - U2	2	630-6N138-000E	6N138	DIP-8	Optocoupler
U1 - U2	2	437-1108730441001101	IC Socket 2x 4 Pin	DIP-8	Socket for Optocoupler
U3	1	771-74HC14D-T	74HC14	SOIC-14	SOLDER SKILLS
Cable	1	617-09180407001	Flat		a quantity forEver

copy following Lines in the box - and make a new project

649-1012938192001BLF|1

571-8815451|12

187-CL31B104KBCNNND|4

963-TMK316AB7106KLHT|2

241-1N4148W_R1_00001|4

571-12150790|2

571-1-2178712-0|4

490-SJ1-3535NG|6

696-SSL-LX30FT4ID|2

696-SSL-LX30FT4GD|2

RC1206FR-07220RL|14
 CR1206-JW-472ELF|4
 AC1206FR-071KL|2
 630-6N138-000E|2
 437-1108730441001101|2
 771-74HC14D-T|1
 617-09180407001|1

then decide **how often you want to order all off, the BOM Quantity is for 1Module**

On one PCB you have 2 ident MidiIO-Modules, on JLCPCB you order typically 5 PCB, so your quantity may be 10x

BUT dont buy multiple Flatbandcables... these are hundrets of meter!

1 times: 45€ 25€ parts and 20€ shipping...shipping excl fat

if you go over 50€ shipping is free.

lets take a look if we order it

5 times: 95€ incl free shipping excl fat

10times:176€ incl free shipping excl fat

4x (or 20x) [Leiterplatten Montageblock aka Standoffs](#) 100x summed 30€

You will also need M3 Screws - 2 off them...

Also here it is clever to order 100 pieces for a cheaper price - you will need this on all my projects...

Frontpanel

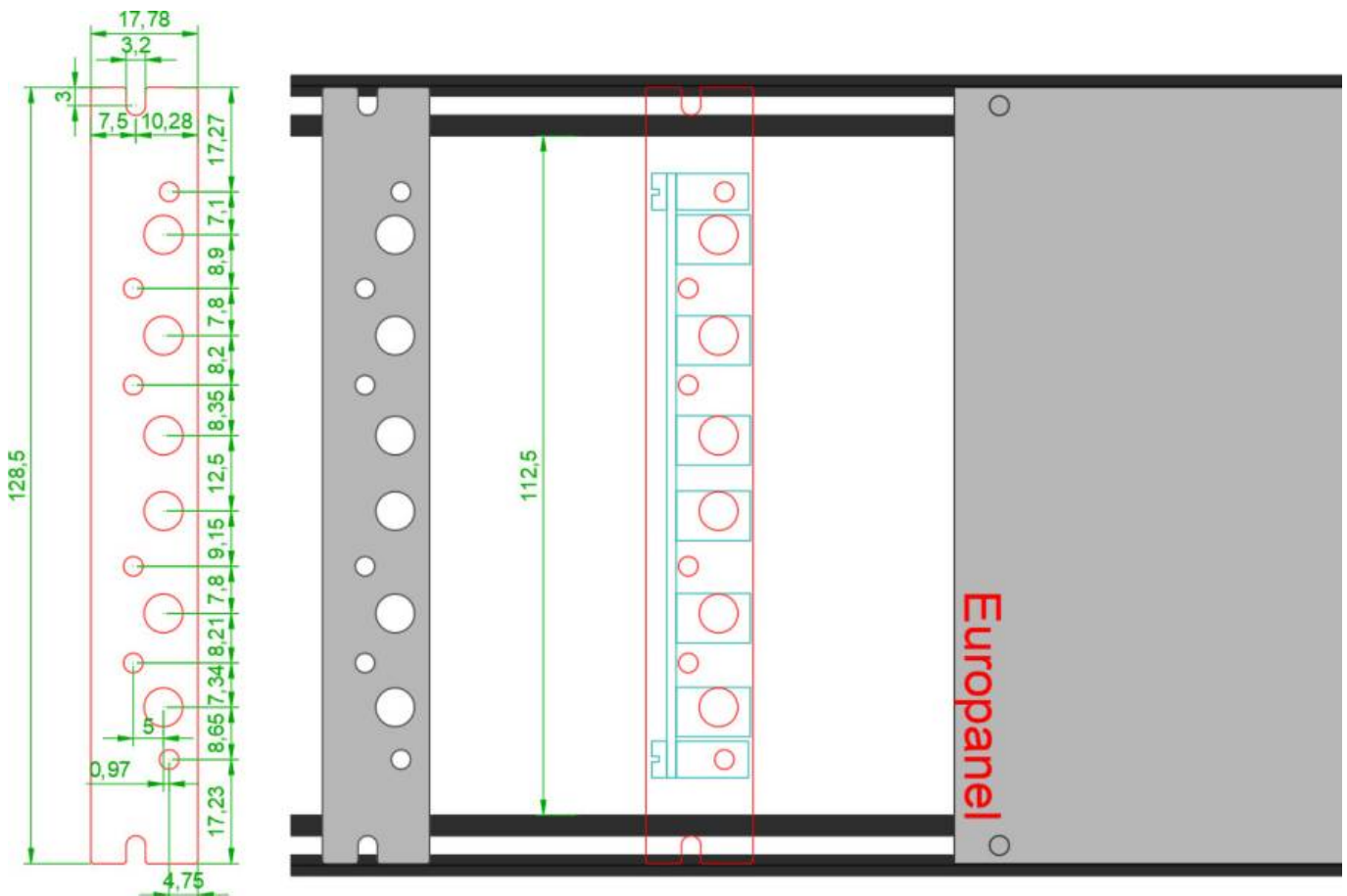

I made a DXF File which you can print, and drill it DIY or

you can send to: (once the prototype state is gone)

frontpanels.de in germany 17,08€ a panel (5x-10%, 10x-20%, 20x-30%, 30x-40%, 100x-50%

[The Beast - UK](http://TheBeast-UK.com)

Schaeffer-ag.de

Recommend Material

2mm x 128.5 x 17.78 Aluminium, anodised

[frontpanel-euromidi.zip](#) - NOT TESTET

A cheaper way is: order a 1,6mm thick Aluminium PCB as Frontpanel:

I will test this... this are the gerbers:

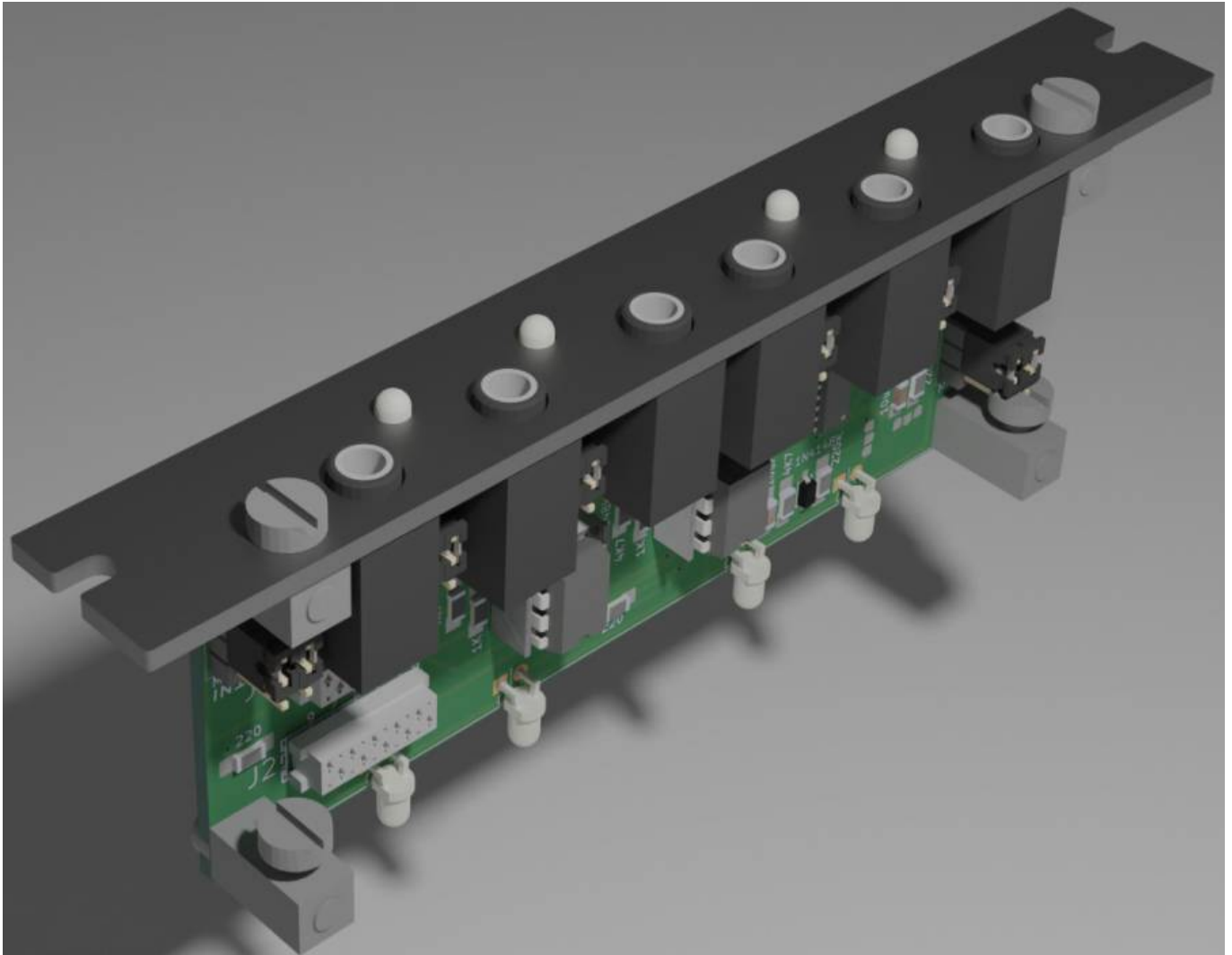

To Do

Since i already debugged Rev.A - and this is the overworked Rev.B - there should not be much to do, except to test the gerber filers... i am happy with Rev.A (have still PCBs so no check of RevB in near future!)

Community users working on it

- **Phatline** = PCB & Schematic, Documentation...

Just let a Private message on the forum to user already involved.

From:

<http://www.midibox.org/dokuwiki/> - **MIDIbox**

Permanent link:

<http://www.midibox.org/dokuwiki/doku.php?id=euro-midi-io&rev=1644128557>

Last update: **2022/02/06 06:22**

