

TLC5958 48-Channel, 16-Bit ES-PWM LED Driver with Pre-Charge FET, LED Open Detection and Display Data Memory Support 32-Multiplexing

1 Features

- 48 Channels Constant Current Sink Output
- Sink Current Capability with Max BC/CC data:
 - 25mA at 5VCC
 - 20mA at 3.3VCC
- Global Brightness Control (BC) : 3-Bit (8 Step)
- Color Brightness Control (CC) for Each Color Group:
 - 9-Bit (512 Step), Three Groups
- Grayscale(GS) Control with Multiplexed Enhanced Spectrum(ES) PWM: 16bit
- 48K bit Grayscale Data Memory Support 32-multiplexing
- LED Power Supply Voltage Up To 10V
- Vcc = 3.0V to 5.5V
- Constant Current Accuracy
 - Channel to Channel = $\pm 1\%$ (Typ), $\pm 3\%$ (Max)
 - Device to Device = $\pm 1\%$ (Typ), $\pm 2\%$ (Max)
- Data Transfer Rate: 25MHz
- Gray Scale Clock: 33MHz
- LED Open Detection (LOD)
- Thermal Shut Down (TSD)
- I_{REF} Resistor Short Protection (ISP)
- Power-Save Mode (PSM) with high speed recovery
- Delay Switching to Prevent Inrush Current
- Pre-charge FET to Avoid Ghosting Phenomenon
- Operating Temperature : -40°C to $+85^{\circ}\text{C}$

2 Applications

- LED Video Displays with Multiplexing System
- LED Signboards with Multiplexing system
- High Refresh Rate & High density LED Panel

3 Description

The TLC5958 is a 48 channels constant-current sink driver for multiplexing system with 1 to 32 duty ratio. Each channel has an individually-adjustable, 65536-step, pulse width modulation (PWM) grayscale (GS).

48K bit display memory is implemented to increase the visual refresh rate and to decrease the GS data writing frequency.

The output channels are grouped into three groups, each group has 16 channels. Each group has a 512-step color brightness control (CC) function. The maximum current value of all 48 channels can be set by 8-step global brightness control (BC) function. CC and BC can be used to adjust the brightness deviation between LED drivers. GS, CC, and BC data are accessible via a serial interface port.

Send request via [email](#) for Application Note: *Build High Density, High Refresh Rate, Multiplexing LED Panel with TLC5958.*

Device Information(1)

PART NUMBER	PACKAGE	BODY SIZE (NOM)
TLC5958	VQFN (56)	8.00 mm x 8.00 mm

(1) For all available packages, see the orderable addendum at the end of the datasheet.

4 Typical Application Circuit (Multiple Daisy-Chaind TLC5958s)

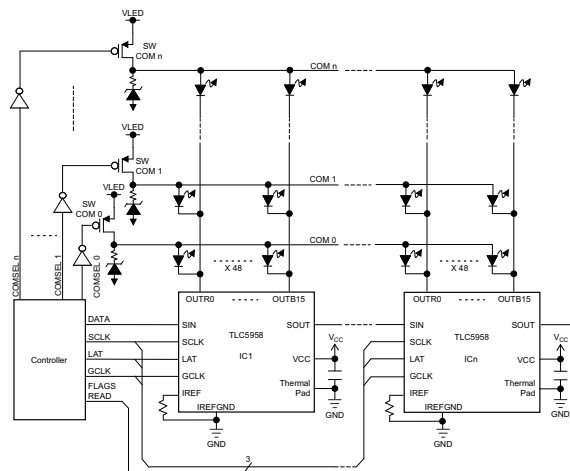

Table of Contents

1 Features	1	Diagrams.....	11
2 Applications	1	9.2 Timing Diagrams	13
3 Description	1	10 Detailed Description	14
4 Typical Application Circuit (Multiple Daisy- Chained TLC5958s)	1	10.1 Overview	14
5 Revision History	2	10.2 Functional Block Diagram	15
6 Description (Continued)	3	10.3 Device Functional Modes.....	16
7 Pin Configuration and Functions	3	11 Application and Implementation	20
8 Specifications	5	12 Power Supply Recommendations	20
8.1 Absolute Maximum Ratings	5	13 Layout	20
8.2 Handling Ratings	5	13.1 Layout Guidelines	20
8.3 Recommended Operating Conditions.....	5	13.2 Layout Example	20
8.4 Thermal Information	6	14 Device and Documentation Support	21
8.5 Electrical Characteristics.....	7	14.1 Trademarks	21
8.6 Typical Characteristics.....	9	14.2 Electrostatic Discharge Caution.....	21
9 Parameter Measurement Information	11	14.3 Glossary	21
9.1 Pin Equivalent Input and Output Schematic		15 Mechanical, Packaging, and Orderable Information	21

5 Revision History

Changes from Original (May 2014) to Revision A

Page

• Deleted Product Preview banner - set to Production Data; global change	1
--	----------

6 Description (Continued)

The TLC5958 has one error flag: LED open detection (LOD), which can be read via a serial interface port. The TLC5958 also has a power-save mode that sets the total current consumption to 0.8mA (typ) when all outputs are off.

7 Pin Configuration and Functions

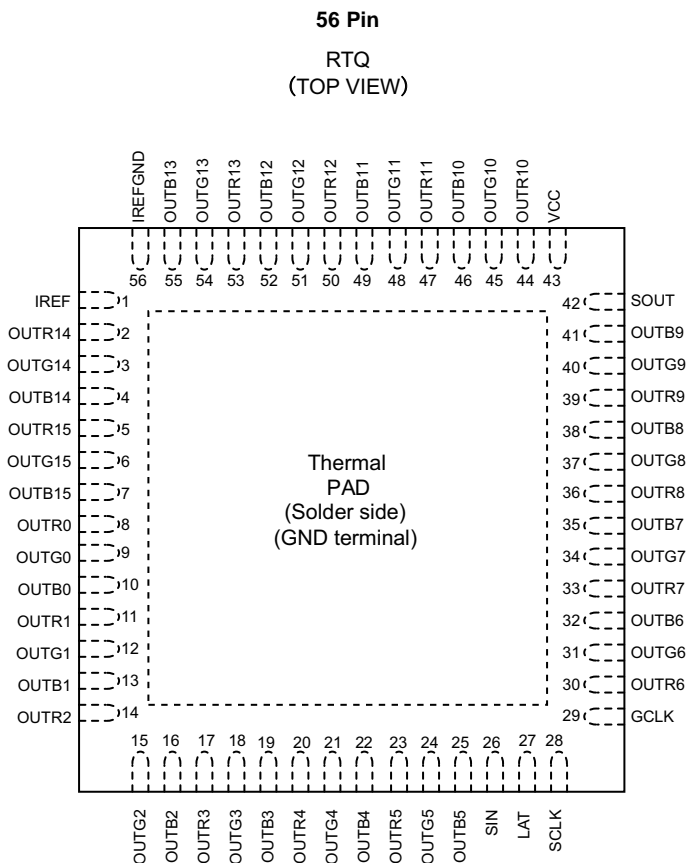

Pin Functions

PIN		I/O	DESCRIPTION
NAME	NO.		
GCLK	29	I	Grayscale(GS) pulse width modulation (PWM) reference clock control for OUTXn. Each GCLK rising edge increase the GS counter by1 for PWM control.
GND	ThermalPad	–	Power ground. The thermal pad must be soldered to GND on PCB.
IREF	1	–	Maximum constant-current value setting. The OUTR0 to OUTB15 maximum constant output current are set to the desired values by connecting an external resistor between IREF and IREFGND. See equation 1 for more detail. The external resistor should be placed close to the device.
IREFGND	56	–	Analog ground. Dedicated ground pin for the external IREF resistor. This pin should be connected to analog ground trace which is connected to power ground near the common GND point of board.
LAT	27	I	The LAT falling edge latches the data from the common shift register into the GS data memory or Function control(FC) register FC1 or FC2.
OUTR0-R15	8, 11, 14, 17, 20, 23, 30, 33, 36, 39, 44, 47, 50, 53, 2, 5	O	Constant current output for RED LED. Multiple outputs can be tied together to increase the constant current capability. Different voltages can be applied to each output. These outputs are turned on-off by GCLK signal and the data in GS data memory.

Pin Functions (continued)

PIN		I/O	DESCRIPTION
NAME	NO.		
OUTG0-G15	9, 12, 15, 18, 21, 24, 31, 34, 37, 40, 45, 48, 51, 54, 3, 6	O	Constant current output for GREEN LED. Multiple outputs can be tied together to increase the constant current capability. Different voltages can be applied to each output. These outputs are turned on-off by GCLK signal and the data in GS data memory.
OUTB0-B15	10, 13, 16, 19, 22, 25, 32, 35, 38, 41, 46, 49, 52, 55, 4, 7	O	Constant current output for BLUE LED. Multiple outputs can be tied together to increase the constant current capability. Different voltages can be applied to each output. These outputs are turned on-off by GCLK signal and the data in GS data memory.
SCLK	28	I	Serial data shift clock. Data present on SIN are shifted to the 48-bit common shift register LSB with the SCLK rising edge. Data in the shift register are shifted towards the MSB at each SCLK rising edge. The common shift register MSB appears on SOUT.
SIN	26	I	Serial data input of the 48-bit common shift register. When SIN is high level, the LSB is set to '1' for only one SCLK input rising edge. If two SCLK rising edges are input while SIN is high, then the 48-bit shift register LSB and LSB+1 are set to '1'. When SIN is low, the LSB is set to '0' at the SCLK input rising edge.
SOUT	42	O	Serial data output of the 48-bit common shift register. SOUT is connected to the MSB of the register.
VCC	43	–	Power-supply voltage.

8 Specifications

8.1 Absolute Maximum Ratings

over operating free-air temperature range (unless otherwise noted) ⁽¹⁾

PARAMETER			MIN	MAX	UNIT
V _{CC} ⁽²⁾	Supply voltage	VCC	0.3	6.0	V
I _{OUT}	Output current (dc)	OUTx0 to OUTx15, x=R, G, B		30	mA
V _{IN} ⁽²⁾	Input voltage	SIN, SCLK, LAT, GCLK, IREF	-0.3	V _{CC} +0.3	V
V _{OUT} ⁽²⁾	Output voltage	SOUT	-0.3	V _{CC} +0.3	V
		OUTx0 to OUTx15, x=R, G, B	-0.3	11	
T _{J(MAX)}	Operating junction temperature			150	°C

- (1) Stresses beyond those listed under *Absolute Maximum Ratings* may cause permanent damage to the device. These are stress ratings only, which do not imply functional operation of the device at these or any other conditions beyond those indicated under *Recommended Operating Conditions*. Exposure to absolute-maximum-rated conditions for extended periods may affect device reliability.
- (2) All voltage values are with respect to device ground terminal.

8.2 Handling Ratings

			MIN	MAX	UNIT
T _{stg}	Storage temperature range		-55	150	°C
V _(ESD) ⁽¹⁾	Electrostatic discharge	Human body model (HBM), per ANSI/ESDA/JEDEC JS-001, all pins ⁽²⁾	0	4000	V
		Charged device model (CDM), per JEDEC specification JESD22-C101, all pins ⁽³⁾	0	1000	

- (1) Electrostatic discharge (ESD) measures device sensitivity and immunity to damage caused by assembly line electrostatic discharges into the device.
- (2) Level listed above is the passing level per ANSI, ESDA, and JEDEC JS-001. JEDEC document JEP155 states that 500-V HBM allows safe manufacturing with a standard ESD control process.
- (3) Level listed above is the passing level per EIA-JEDEC JESD22-C101. JEDEC document JEP157 states that 250-V CDM allows safe manufacturing with a standard ESD control process.

8.3 Recommended Operating Conditions

At T_A = -40°C to +85°C, unless otherwise noted

			MIN	NOM	MAX	UNIT
DC CHARACTERISTICS, VCC=3V to 5.5V						
V _{CC}	Supply voltage		3		5.5	V
V _O	Voltage applied to output	OUTx0 to OUTx15, x=R, G, B			10	V
V _{IH}	High level input voltage	SIN,SCLK,LAT,GCLK	0.7×VCC		VCC	V
V _{IL}	Low level input voltage	SIN,SCLK,LAT,GCLK	GND		0.3×VCC	V
I _{OH}	High level output current	SOUT			-2	mA
I _{OL}	Low level output current	SOUT			2	mA
I _{OLC}	Constant output sink current	OUTx0 to OUTx15, x=R, G, B, 3V ≤ VCC ≤ 3.6V			20	mA
		OUTx0 to OUTx15, x=R, G, B, 4V < VCC ≤ 5.5V			25	
T _A	Operating free air temperature		-40		85	°C
T _J	Operation junction temperature		-40		125	°C

Recommended Operating Conditions (continued)

 At $T_A = -40^{\circ}\text{C}$ to $+85^{\circ}\text{C}$, unless otherwise noted

			MIN	NOM	MAX	UNIT
AC CHARACTERISTICS, VCC=3V to 5.5V⁽¹⁾						
$F_{\text{CLK(SCLK)}}$	Data shift clock frequency	SCLK			25	MHz
$F_{\text{CLK(GCLK)}}$	Grayscale control clock frequency	GCLK			33	MHz
t_{WH0}	Pulse duration	SCLK	10			ns
t_{WL0}		SCLK	10			
t_{WH1}		GCLK	15			
t_{WL1}		GCLK	10			
t_{SU0}	Setup time	SIN - SCLK \uparrow	2			ns
t_{SU1}		LAT \uparrow - SCLK \uparrow	3			
t_{SU2}		LAT \downarrow - SCLK \uparrow	5			
		LAT \downarrow - SCLK \uparrow , for READSID, READFC1, and READFC2	50			
t_{SU3}		LAT \downarrow (Vsync command) - GCLK \uparrow	2500			
t_{SU4}		The last LAT \downarrow for no all '0' data latching to resume normal mode – GCLK \uparrow , PSAVE_ENA bit = '1b'	50			μS
t_{SU5}	The last GCLK \uparrow - the 1st GCLK \uparrow of next line	20			ns	
t_{H0}	Hold time	SCLK \uparrow - SIN	2			ns
t_{H1}		SCLK \uparrow - LAT \uparrow	2			
t_{H2}		SCLK \uparrow - LAT \downarrow	13			

(1) Specified by design

8.4 Thermal Information

THERMAL METRIC ⁽¹⁾		TLC5958	UNIT
		RTQ	
		56 PINS	
$R_{\theta\text{JA}}$	Junction-to-ambient thermal resistance	27.4	$^{\circ}\text{C}/\text{W}$
$R_{\theta\text{JC(top)}}$	Junction-to-case (top) thermal resistance	13.6	
$R_{\theta\text{JB}}$	Junction-to-board thermal resistance	5.5	
Ψ_{JT}	Junction-to-top characterization parameter	0.2	
Ψ_{JB}	Junction-to-board characterization parameter	5.5	
$R_{\theta\text{JC(bot)}}$	Junction-to-case (bottom) thermal resistance	0.8	

 (1) For more information about traditional and new thermal metrics, see the *IC Package Thermal Metrics* application report, [SPRA953](http://www.ti.com/lit/zip/spra953).

8.5 Electrical Characteristics

At $V_{CC} = 3.0V$ to $5.5V$ and $T_A = -40^\circ C$ to $85^\circ C$, $V_{LED} = 5.0V$, Typical values are at $V_{CC} = 3.3V$, $T_A = 25^\circ C$ (unless otherwise noted).

PARAMETER			TEST CONDITIONS	MIN	TYP	MAX	UNIT
V_{OH}	Output voltage	High	$I_{OH} = -2mA$ at SOUT	$V_{CC}-0.4$		V_{CC}	V
V_{OL}		Low	$I_{OL} = 2 mA$ at SOUT			0.4	V
V_{LOD0}	LED open detection threshold		LODVTH = 00b	0.06	0.11	0.16	V
V_{LOD1}			LODVTH = 01b	0.2	0.25	0.3	
V_{LOD2}			LODVTH = 10b	0.34	0.39	0.44	
V_{LOD3}			LODVTH = 11b	0.44	0.49	0.54	
V_{REF}	Reference voltage output		$R_{REF} = 6.2 k\Omega$ (1mA target), BC=0h, CCR/G/B=81h	1.19	1.209	1.228	V
I_{IN}	Input current (SIN, SCLK)		$V_{IN} = V_{CC}$ or GND	-1		1	μA
I_{CC0}	Supply current (V_{CC})		SIN/SCLK/LAT/GSCLK=GND, GS _n =0000h, BC=0h, CCR/G/B=81h, VOUT _n = V_{CC} , RIREF=OPEN		5.5	7	mA
I_{CC1}			SIN/SCLK/LAT/GSCLK=GND, GS _n =0000h, BC=4h, CCR/G/B=137h, VOUT _n = V_{CC} , RIREF=7.5k Ω (I_o =10mA target)		7	9	
I_{CC2}			SIN/SCLK/LAT=GND, GCLK=33MHz, T _{SU5} = 200nS, 8+8 mode, GS _n =FFFFh, BC=4h, CCR/G/B=137h, VOUT _n = $V_{CC}-1V$ when channel on, VOUT _n = V_{CC} when channel off. RIREF=7.5k Ω (I_o =10mA target)		25	31	
I_{CC3}			SIN/SCLK/LAT=GND, GCLK=33MHz, TSU5=200nS, 8+8 mode, GS _n =FFFFh, BC=7h, CCR/G/B=1F5h, VOUT _n = $V_{CC}-2.5V$ when channel on, VOUT _n = V_{CC} when channel off. RIREF=7.5k Ω (I_o =25mA target)		28	33	
I_{CC4}			In power save mode		0.9	1.5	
ΔI_{OLC0}	Constant current error (OUT _{x0-15} , x=R/G/B)	Channel-to-channel ⁽¹⁾	All OUT _n =on, BC=0h, CCR/G/B=81h, VOUT _n =VOUT _{fix} =1V, RIREF=6.2k Ω (1mA target), $T_A = +25^\circ C$, at same color grouped output of OUT _{R0-15} , OUT _{G0-15} and OUT _{B0-15}		$\pm 1\%$	$\pm 3\%$	
ΔI_{OLC1}	Constant current error (OUT _{x0-15} , x=R/G/B)	Device-to-device ⁽²⁾	All OUT _n =on, BC=0h, CCR/G/B=81h, VOUT _n =VOUT _{fix} =1V, RIREF=6.2k Ω (1mA target), $T_A = +25^\circ C$, at same color grouped output of OUT _{R0-15} , OUT _{G0-15} and OUT _{B0-15}		$\pm 1\%$	$\pm 2\%$	
ΔI_{OLC2}	Line regulation ⁽³⁾		$V_{CC}=3.0$ to $5.5V$, All OUT _n =on, BC=0h, CCR/G/B=81h, VOUT _n =VOUT _{fix} =1V, RIREF=6.2k Ω (1mA target)		± 1	± 1.5	%/V
ΔI_{OLC3}	Load regulation ⁽⁴⁾		All OUT _n =on, BC=0h, CCR/G/B=81h, VOUT _n =1 to 3V, VOUT _{fix} =1V, RIREF=6.2k Ω (1mA target)		± 1	± 1.5	%/V

- (1) The deviation of each outputs in same color group (OUT_{R0-15} or OUT_{G0-15} or OUT_{B0-15}) from the average of same color group constant current. The deviation is calculated by the formula. (X=R or G or B, n=0-15)

$$\Delta(\%) = \left[\frac{I_{OUTXn}}{(I_{OUTX0} + I_{OUTX1} + \dots + I_{OUTX14} + I_{OUTX15})} - 1 \right] \times 100$$

- (2) The deviation of the average of constant-current in each color group from the ideal constant-current value. (X = R or G or B) :

$$\Delta(\%) = \left[\frac{(I_{OUTX0} + I_{OUTX1} + \dots + I_{OUTX15})}{16} - (\text{Ideal Output Current}) \right] \times 100$$

Ideal current is calculated by the following equation:

$$\text{Ideal Output (mA)} = \text{Gain} \times \left[\frac{V_{REF}}{R_{REF}(\Omega)} \right] \times \text{CCR (or CCG, CCB)} / 511d, V_{REF} = 1.209V \text{ (Typ.)}$$

Refer to Table 1 for the Gain at chosen BC.

- (3) Line regulation is calculated by the following equation. (X=R or G or B, n=0-15):

$$\Delta(\%V) = \left[\frac{(I_{OUTXn} \text{ at } V_{CC} = 5.5V) - (I_{OUTXn} \text{ at } V_{CC} = 3.0V)}{(I_{OUTXn} \text{ at } V_{CC} = 3.0V)} \right] \times \frac{100}{5.5V - 3V}$$

- (4) Load regulation is calculated by the following equation. (X=R or G or B, n=0-15):

$$\Delta(\%V) = \left[\frac{(I_{OUTXn} \text{ at } V_{OUTXn} = 3V) - (I_{OUTXn} \text{ at } V_{OUTXn} = 1V)}{(I_{OUTXn} \text{ at } V_{OUTXn} = 1V)} \right] \times \frac{100}{3V - 1V}$$

Electrical Characteristics (continued)

At $V_{CC}=3.0V$ to $5.5V$ and $T_A=-40^{\circ}C$ to $85^{\circ}C$, $V_{LED}=5.0V$, Typical values are at $V_{CC}=3.3V$, $T_A=25^{\circ}C$ (unless otherwise noted).

PARAMETER			TEST CONDITIONS	MIN	TYP	MAX	UNIT
ΔI_{OLC4}	Constant current error (OUTx0-15, x=R/G/B)	Channel-to-channel ⁽¹⁾	All OUTn=on, BC=7h, CCR/G/B=1F7h, VOUTn=VOUTfix=1V, RIREF=7.5k Ω (25mA target), $T_A=+25^{\circ}C$, at same color grouped output of OUTRO-15, OUTG0-15 & OUTB0-15		$\pm 1\%$	$\pm 3\%$	
ΔI_{OLC5}	Constant current error (OUTx0-15, x=R/G/B)	Device-to-device ⁽²⁾	All OUTn=on, BC=7h, CCR/G/B=1F7h, VOUTn=VOUTfix=1V, RIREF=7.5k Ω (25mA target), $T_A=+25^{\circ}C$, at same color grouped output of OUTRO-15, OUTG0-15 and OUTB0-15		$\pm 1\%$	$\pm 2\%$	
ΔI_{OLC6}	Line regulation ⁽³⁾		$V_{CC}=3.0$ to $5.5V$, All OUTn=on, BC=7h, CCR/G/B=1F7h, VOUTn=VOUTfix=1V, RIREF=7.5k Ω (25mA target)		± 1	± 1.5	%/V
ΔI_{OLC7}	Load regulation ⁽⁴⁾		All OUTn=on, BC=7h, CCR/G/B=1F7h, VOUTn=1 to 3V, VOUTfix=1V, RIREF=7.5k Ω (25mA target)		± 1	± 1.5	%/V
T_{TSD}	Thermal shutdown threshold ⁽⁵⁾			160	170	180	$^{\circ}C$
T_{HYS}	Thermal shutdown hysteresis				10		$^{\circ}C$
$V_{ISP(in)}$	IREF resistor short protection threshold			0.135	0.19		V
$V_{ISP(out)}$	IREF resistor short-protection release threshold				0.325	0.375	V
R_{PDWN}	Pull-down resistor		LAT	250	500	750	k Ω
R_{PUP}	Pull-up resistor		GCLK	250	500	750	k Ω
V_{knee} ⁽⁵⁾	Knee voltage (OUTX 0~15), X=R/G/B		All OUTn=on, BC=4h, CCR/G/B=137h, Riref=7.5k Ω . (Io=10mA target)		0.32	0.35	V

(5) Specified by design.

8.6 Typical Characteristics

$V_{CC} = 3.3V$ and $T_A = 25^\circ C$, unless otherwise noted.

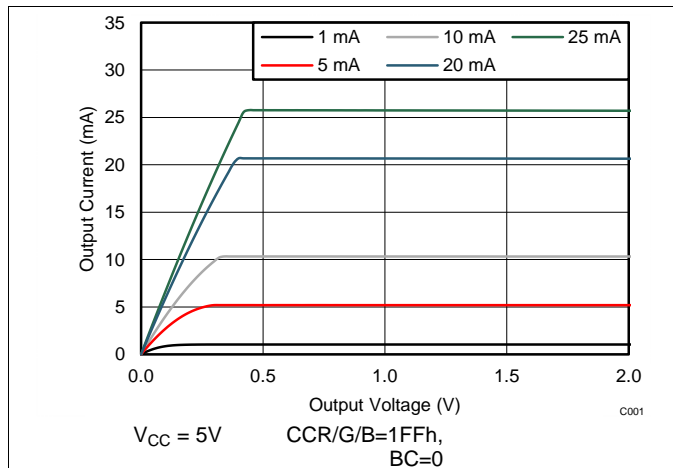

Figure 1. Output Current vs Output Voltage

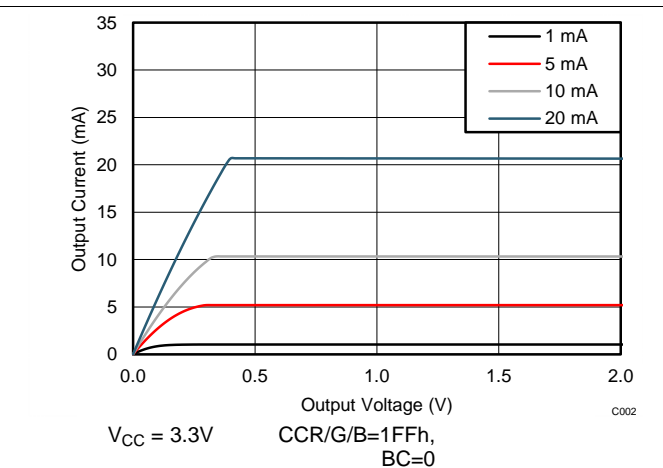

Figure 2. Output Current vs Output Voltage

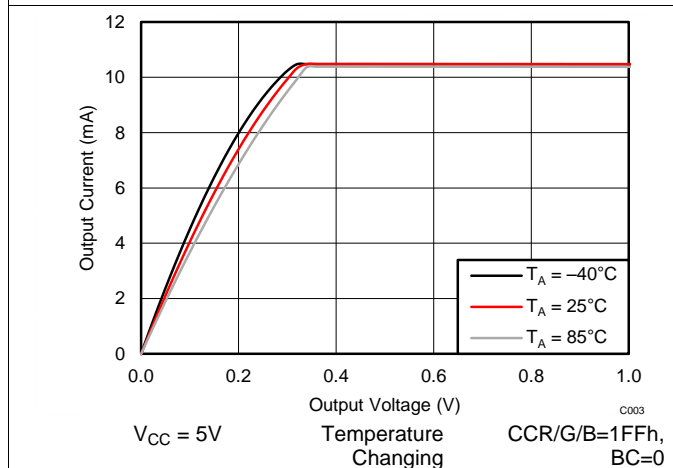

Figure 3. Output Current vs Output Voltage

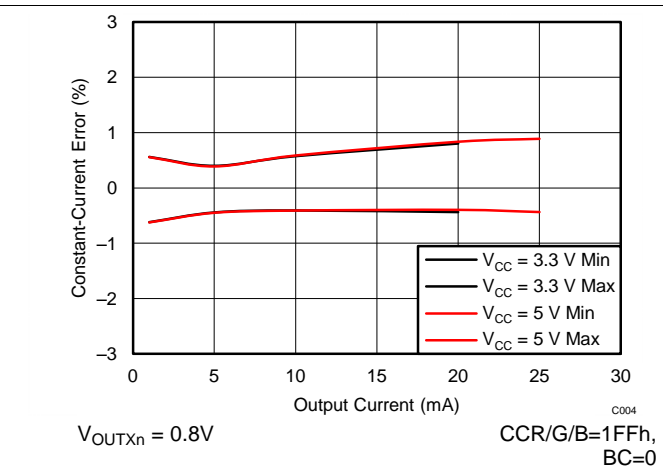

Figure 4. Constant Current Error (CH-to-CH) vs Output Current

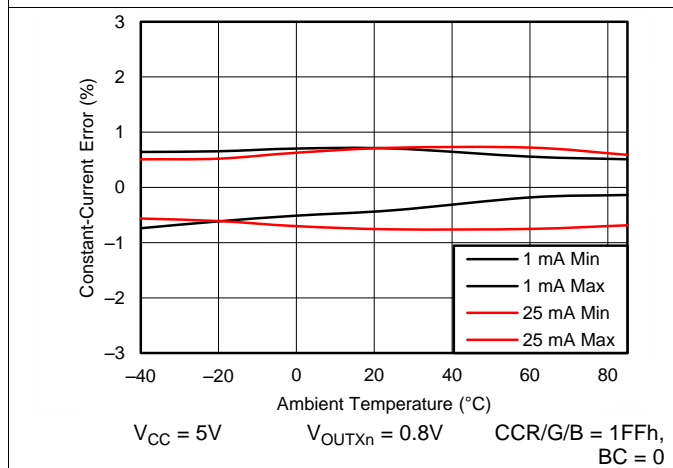

Figure 5. Constant-Current Error (CH-to-CH) vs Temperature

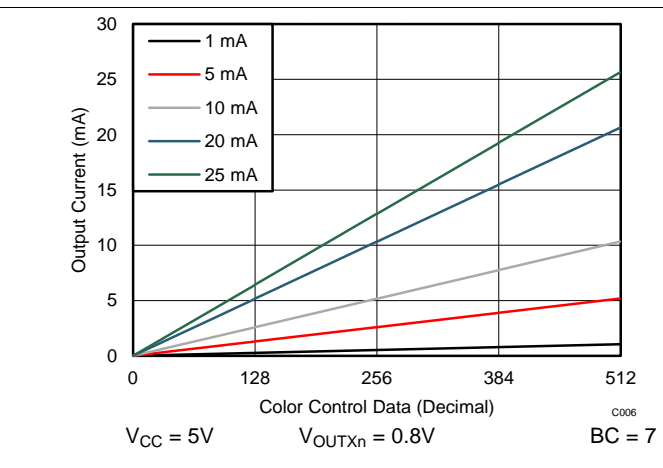

Figure 6. Color Control (CC) vs Output Current

Typical Characteristics (continued)

$V_{CC} = 3.3V$ and $T_A = 25^\circ C$, unless otherwise noted.

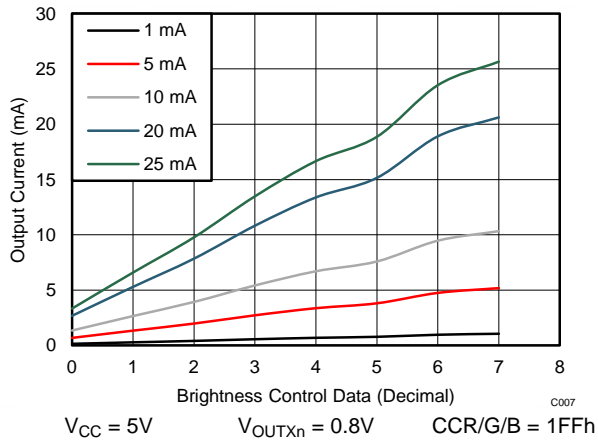

Figure 7. Brightness Control (BC) vs Output Current

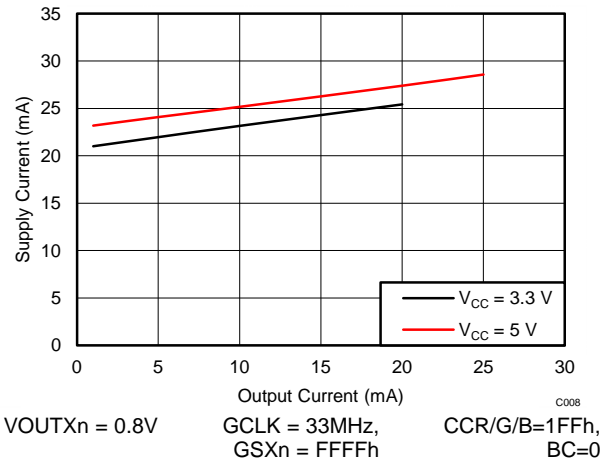

Figure 8. Supply Current (I_{cc}) vs Output Current

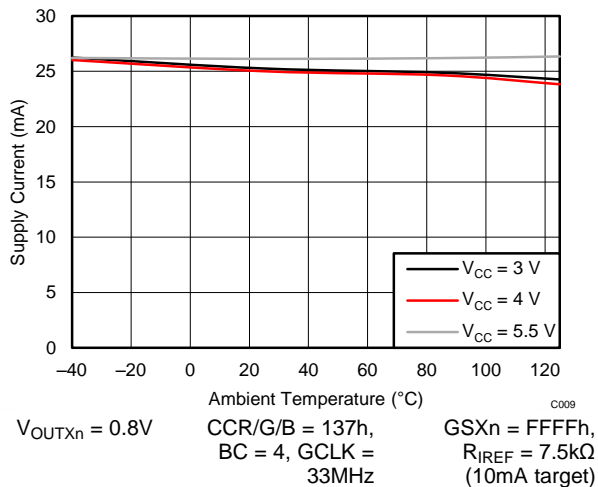

Figure 9. Supply Current (I_{cc}) vs Temperature

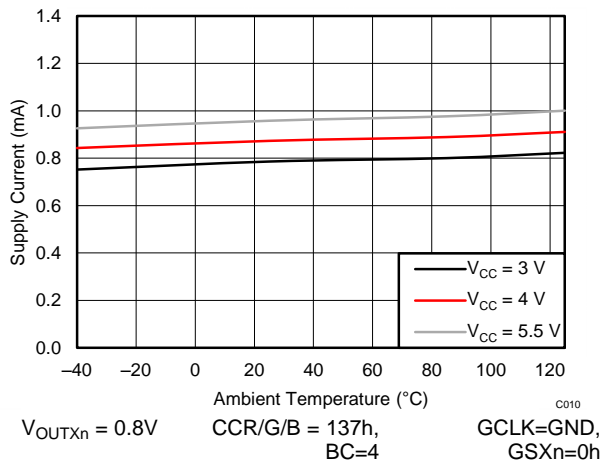

Figure 10. Supply Current in Power Save Mode (I_{cc}) vs Temperature

9 Parameter Measurement Information

9.1 Pin Equivalent Input and Output Schematic Diagrams

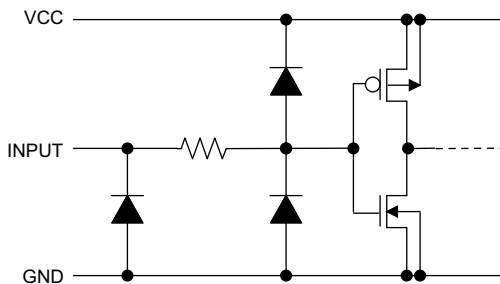

Figure 11. SIN, SCLK

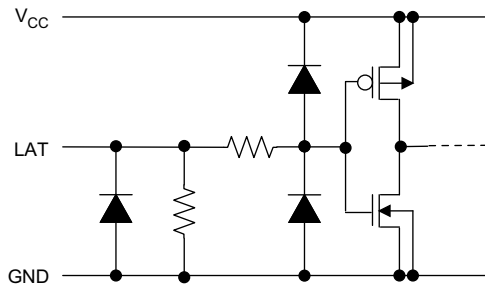

Figure 12. LAT

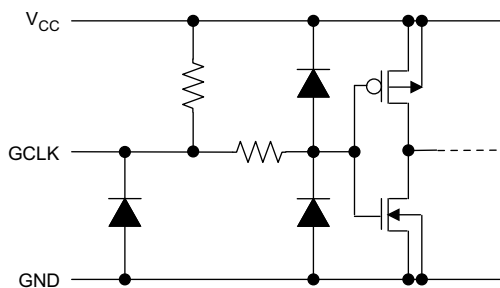

Figure 13. GCLK

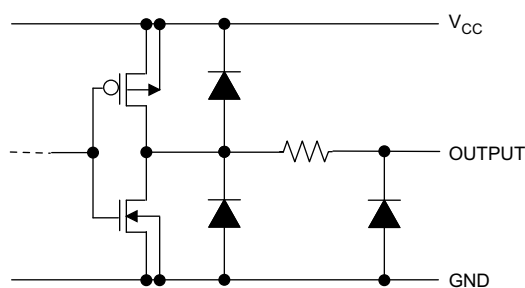

Figure 14. SOUT

(1) X=R or G or B, n=0-15

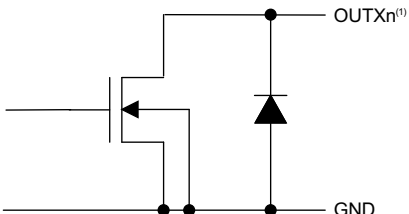

Figure 15. OUTR0/G0/B0 Through OUTR15/G15/B15

Pin Equivalent Input and Output Schematic Diagrams (continued)

9.1.1 Test Circuits

- (1) CL includes measurement probe and jig capacitance.
- (2) X=R or G or B, n=0~15
- (1) CL includes measurement probe and jig capacitance.

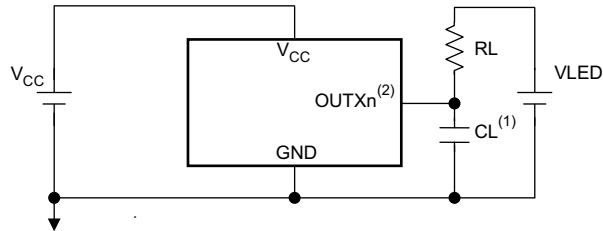

Figure 16. Rise Time and Fall Time Test Circuit for OUTXn

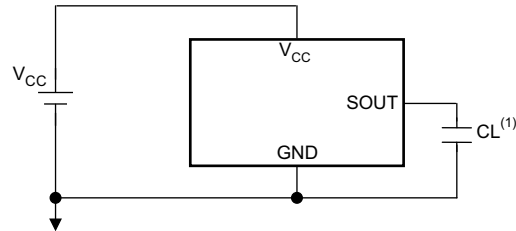

Figure 17. Rise Time and Fall Time Test Circuit for SOUT

- (1) X=R or G or B, n=0~15

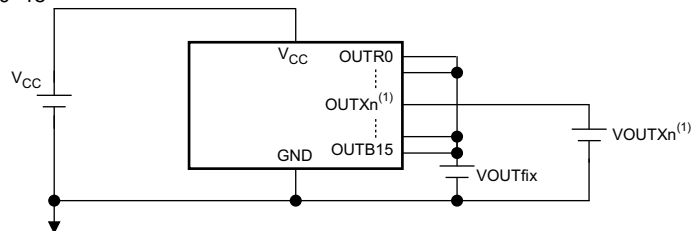
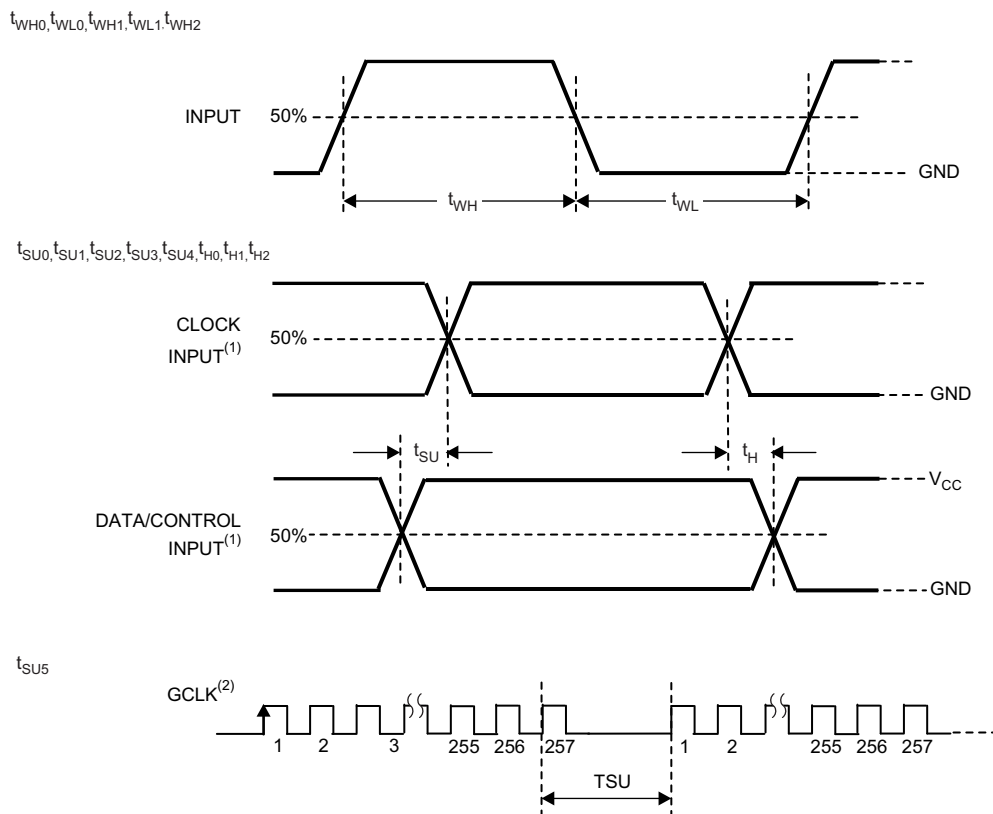

Figure 18. Constant Current Test Circuit for OUTXn

9.2 Timing Diagrams



(1) Input pulse rise and fall time is 1~3ns

(2) 8 + 8 mode (SEL_PWM=0)

Figure 19. Timing Diagrams

10 Detailed Description

10.1 Overview

The TLC5958 is a 48 channels constant-current sink driver for multiplexing system with 1 to 32 duty ratio. Each channel has an individually-adjustable, 65536-step, pulse width modulation (PWM) grayscale (GS).

48K bit display memory is implemented to increase the visual refresh rate and to decrease the GS data writing frequency.

The TLC5958 support output current range from 1mA to 25mA, channel-to-channel accuracy is 3% max, device-to-device accuracy is 2% max in all current range. Besides, it implement Low Gray Scale Enhancement (LGSE™) technology to improve the display quality at low grayscale condition. These features make TLC5958 more suitable for high-density multiplexing application.

The output channels are grouped into three groups, each group has 16 channels. Each group has a 512-step color brightness control (CC) function. The maximum current value of all 48 channels can be set by 8-step global brightness control (BC) function. CC and BC can be used to adjust the brightness deviation between LED drivers. GS, CC, and BC data are accessible via a serial interface port.

The TLC5958 has one error flag: LED open detection (LOD), which can be read via a serial interface port. Besides, The TLC5958 also have Thermal shut down(TSD) and Iref resistor short protection(ISP), which make sure a higher system reliability. The TLC5958 also has a power-save mode that sets the total current consumption to 0.8mA (typ) when all outputs are off.

10.2 Functional Block Diagram

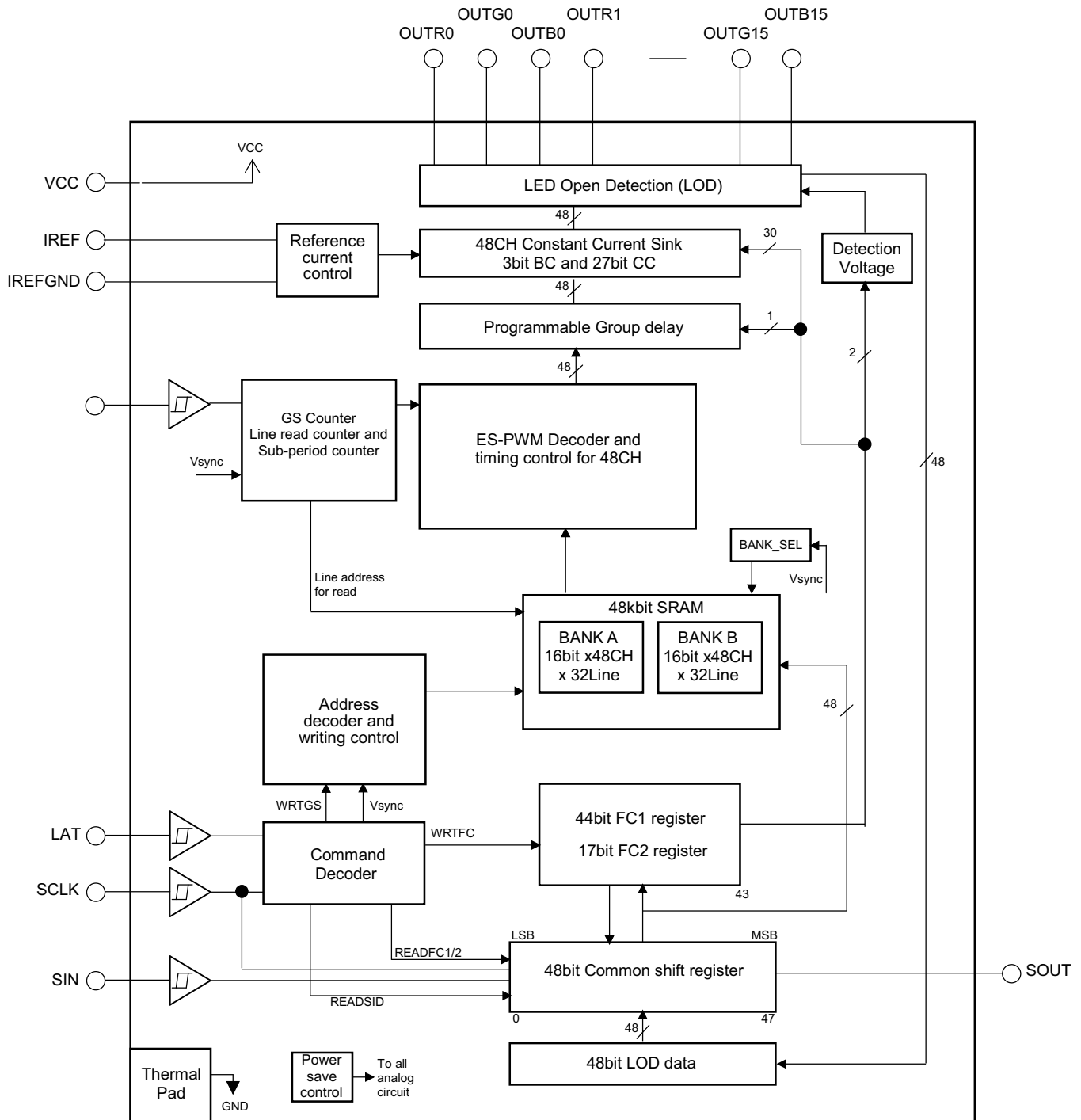

10.3 Device Functional Modes

After power on, all OUTXn of the TLC5958 are turned off. All the internal counters and function control registers (FC1/FC2) are initialized. The following list is a brief summary of the sequence to operate the TLC5958, to give users a general idea how the device works. After that, the function block related to each step is detailed in the following sections.

1. According to required LED current, choose BC & CC code, select the current programming resistor R_{IREF}.
2. Send WRTFC command to set FC1/2 register value if the default value need be changed.
3. Write GS data of all lines (max 32 lines) into one of the two memory BANKs.
4. Send Vsync command, the BANK with the GS data written just now will be displayed.
5. Input GCLK continuously, 257GCLK (or 513GCLK) as a segment. Between the interval of two segments, supply voltage should be switched from one line to next line accordingly.
6. During the same period of step 5, GS data for next frame should be written into another BANK.
7. When the time of one frame ends, Vsync command should be input to swap the purpose of the two BANKs.

Repeat step 5 through 7.

10.3.1 Brightness Control (BC) Function

The TLC5958 is able to adjust the output current of all constant-current outputs simultaneously. This function is called global brightness control (BC). The global BC for all outputs is programmed with a 3-bit word, thus all output currents can be adjusted in 8 steps from 12.9% to 100% for a given current-programming resistor, R_{IREF} (See Table 2).

BC data can be set via the serial interface. When the BC data changes, the output current also changes immediately. When the device is powered on, the BC data in the function control (FC) register FC1 is set to 4h as the initial value.

10.3.2 Color Brightness Control (CC) Function

The TLC5958 is able to adjust the output current of each of the three color groups OUTR0-OUTR15, OUTG0-OUTG15, and OUTB0-OUTB15 separately. This function is called color brightness control (CC). For each color, it has 9-bit data latch CCR,CCG, or CCB in FC1 register. Thus, all color group output currents can be adjusted in 512 steps from 0% to 100% of the maximum output current, I_{OLCMax}. (See the next section for more detail about I_{OLCMax}). The CC data are entered via the serial interface. When the CC data change, the output current also changes immediately.

When the IC is powered on, the CC data are set to '100h'. Equation 1 calculates the actual output current.

$$I_{out}(mA) = I_{OLCMax}(mA) \times (CCR/511d \text{ or } CCG/511d \text{ or } CCB/511d) \quad (1)$$

Where:

I_{OLCMax} = the maximum channel current for each channel, determined by BC data and R_{IREF} (See [Equation 2](#))

CCR/G/B = the color brightness control value for each color group in the FC1 register (000h to 1FFh)

[Table 1](#) shows the CC data versus the constant-current against I_{OLCMax}.

Device Functional Modes (continued)
Table 1. CC Data vs Current Ratio and Set Current Value

CC DATA (CCR or CCG or CCB)			RATIO OF OUTPUT CURRENT TO I_{OLCMax} (%, typical)	OUTPUT CURRENT (mA, $R_{IREF} = 7.41 \text{ k}\Omega$)	
BINARY	DECIMAL	HEX		BC = 7h ($I_{OLCMax} = 25\text{mA}$)	BC = 0h ($I_{OLCMax} = 3.2\text{mA}$)
0 0000 0000	0	00	0	0	0
0 0000 0001	1	01	0.2	0.05	0.006
0 0000 0010	2	02	0.4	0.10	0.013
---	---	---	---	---	---
1 0000 0000 (Default)	256 (Default)	100 (Default)	50.1	12.52	1.621
---	---	---	---	---	---
1 1111 1101	509	1FD	99.6	24.90	3.222
1 1111 1110	510	1FE	99.8	24.95	3.229
1 1111 1111	511	1FF	100.0	25	3.235

10.3.3 Select R_{IREF} For a Given BC

The maximum output current per channel, I_{OLCMax} , is determined by resistor R_{IREF} , placed between the IREF and IREFGND pins, and the BC code in FC1 register. The voltage on IREF is typically 1.209V. R_{IREF} can be calculated by [Equation 2](#).

$$R_{IREF}(\text{k}\Omega) = V_{IREF}(\text{V}) / I_{OLCMax}(\text{mA}) \times \text{Gain} \quad (2)$$

Where:

V_{IREF} = the internal reference voltage on IREF (1.209V, typical)

I_{OLCMax} is the largest current for each output at CCR/G/B=1FFh.

Gain = the current gain at a selected BC code (See [Table 2](#))

Table 2. Current Gain Versus BC Code

BC DATA		GAIN	RATIO OF GAIN / GAIN_MAX (AT MAX BC)
BINARY	HEX		
000 (recommend)	0 (recommend)	20.4	12.9%
001	1	40.3	25.6%
010	2	59.7	52.4%
011	3	82.4	12.9%
100 (default)	4 (default)	101.8	64.7%
101	5	115.4	73.3%
110	6	144.3	91.7%
111	7	157.4	100%

NOTE: Recommend using a smaller BC code for better performance. For noise immunity purposes, suggest $R_{IREF} < 60 \text{ k}\Omega$

10.3.4 Choosing BC/CC For a Different Application

BC is mainly used for global brightness adjustment between day and night. Suggested BC is 4h, which is in the middle of the range, thus, one can change brightness up and down flexibly.

CC can be used to fine tune the brightness in 512 steps, this is suitable for white balance adjustment between RGB color group. To get a pure white color, the general requirement for the luminous intensity ratio of R, G, B LED is 3:6:1. Depending on the characteristics of the LED (Electro-Optical conversion efficiency), the current ratio of R, G, B LED will be much different from this ratio. Usually, the Red LED needs the largest current. One can choose 511d (the max value) CC code for the color group that needs the largest initial current, then choose proper CC code for the other two color groups according to the current ratio requirement of the LED used.

10.3.4.1 Example 1: Red LED Current is 20mA, Green LED Needs 12mA, Blue LED needs 8mA

1. Red LED needs the largest current, so choose 511d for CCR
2. $511 \times 12\text{mA} / 20\text{mA} = 306.6$, thus choose 307d for CCG. With same method, choose 204d for CCB.
3. According to the required red LED current, choose 7h for BC.
4. According to Equation 2, $R_{\text{REF}} = 1.209\text{V} / 20\text{mA} \times 157.4 = 9.5 \text{ k}\Omega$

In this example, we choose 7h for BC, instead of using the default 4h. This is because the Red LED current is 20mA, approaching the upper limit of current range. To prevent the constant output current from exceeding the upper limit in case a larger BC code is input accidentally, we choose the maximum BC code here.

10.3.4.2 Example 2: Red LED Current is 5mA, Green LED Needs 2mA, Blue LED Needs 1mA.

1. Red LED needs the largest current, so choose 511d for CCR.
2. $511 \times 2\text{mA} / 5\text{mA} = 204.4$, thus choose 204d for CCG. With same method, choose 102d for CCB.
3. According to the required blue LED current, choose 0h for BC.
4. According to Equation 2, $R_{\text{REF}} = 1.209\text{V} / 5\text{mA} \times 20.4 = 4.93 \text{ k}\Omega$

In this example, we choose 0h for BC, instead of using the default 4h. This is because the Blue LED current is 1mA, is approaching the lower limit of current range. To prevent the constant output current from exceeding the lower limit in case a lower BC code is input accidentally, we choose the minimum BC code here. In general, if LED current is in the middle of the range (i.e, 10mA), one can just use the default 4h as BC code.

10.3.5 LED Open Detection (LOD)

The LOD function detects faults caused by an open circuit in any LED string; or, a short from OUTXn to ground with low impedance. It does this by comparing the OUTXn voltage to the LOD detection threshold voltage level set by LODVLT in the FC1 register. If the OUTXn voltage is lower than the programmed voltage, the corresponding output LOD bit will be set to '1' to indicate a open LED. Otherwise, the output of that LOD bit is '0'. LOD data output by the detection circuit are valid only during the 'on' period of that OUTXn output channel. The LOD data are always '0' for outputs that are turned off.

10.3.6 Power Save Mode (PSM)

The power-save mode (PSM) is enabled by setting PSAVE_ENA (bit5 of FC2 register) to '1'. When power on, this bit default is '0'.

When this function is enabled, if the GS data received for next frame is all '0', IC will enter power save mode at the moment Vsync command input.

When the IC is in power-save mode, it resumes normal mode when it detects non-zero GS data input. In power-save mode all analog circuits such as constant current output and the LOD circuit are not operational; the device total current consumption, I_{cc}, is below 1mA.

10.3.7 Internal Pre-Charge FET

The internal pre-charge FET can prevent ghosting of multiplexed LED modules. One cause of this phenomenon is the charging current for parasitic capacitance of the OUTXn through the LED when the supply voltage switches from one common line to the next common line.

To prevent this unwanted charging current, TLC5958 uses an internal FET to pull OUTXn up to VCC –1.4V during the common line switching period. Thus, no charging current flows through LED and ghosting is eliminated.

10.3.8 Thermal Shutdown (TSD)

The thermal shutdown (TSD) function turns off all IC constant-current outputs when the junction temperature (T_j) exceeds 170°C (typ). It resumes normal operation when T_j falls below 160°C (typ).

10.3.9 IREF Resistor Short Protection (ISP)

The Iref resistor short protection (ISP) function prevents unwanted large currents from flowing through the constant-current output when the Iref resistor is shorted accidentally. The TLC5958 turns off all output channels when the Iref pin voltage is lower than 0.19V (typ). When the Iref pin voltage goes higher than 0.325V (typ), the TLC5958 resumes normal operation.

10.3.10 Noise Reduction

Large surge currents may flow through the IC and the board on which the device is mounted if all 48 LED channels turned on simultaneously at the 1st GCLK rising edge. This large surge current could induce detrimental noise and electromagnetic interference (EMI) into other circuits.

The TLC5958 separates the LED channels into 12 groups. Each group turns on sequentially with some delay between one group and the next group. By this operation, a soft-start feature provides for minimal inrush current.

11 Application and Implementation

Send request via [email](#) for Application Note: *Build High Density, High Refresh Rate, Multiplexing LED Panel with TLC5958*

12 Power Supply Recommendations

The V_{CC} power supply voltage should be decoupled by placing a 0.1 μF ceramic capacitor close to VCC pin and GND plane. Depending on panel size, several electrolytic capacitors must be placed on board equally distributed to get a well regulated LED supply voltage (VLED). VLED voltage ripple should be less than 5% of its nominal value. Furthermore, the VLED should be set to the voltage calculated by equation:

$$V_{LED} > V_f + 0.4V \quad (10\text{mA constant current example}) \quad (3)$$

Where: V_f = maximum forward voltage of LED

13 Layout

13.1 Layout Guidelines

1. Place the decoupling capacitor near the VCC pin and GND plane.
2. Place the current programming resistor R_{iref} close to IREF pin and IREFGND pin.
3. Route the GND pattern as widely as possible for large GND currents. Maximum GND current is approximately 1.2A
4. Routing between the LED cathode side and the device OUTXn pin should be as short and straight as possible to reduce wire inductance.
5. The PowerPAD™ must be connected to GND plane because the pad is used as power ground pin internally, there will be large current flow through this pad when all channels turn on. Furthermore, this pad should be connected to a heat sink layer by thermal via to reduce device temperature. One suggested thermal via pattern is shown as below. For more information about suggested thermal via pattern and via size, see "PowerPAD Thermally Enhanced Package", SLMA002G.

13.2 Layout Example

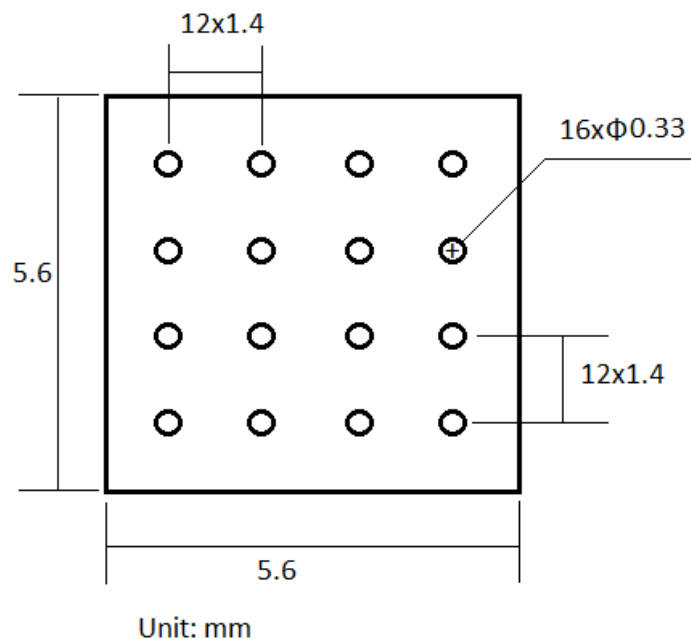

14 Device and Documentation Support

14.1 Trademarks

LGSE, PowerPAD are trademarks of Texas Instruments.
All other trademarks are the property of their respective owners.

14.2 Electrostatic Discharge Caution



These devices have limited built-in ESD protection. The leads should be shorted together or the device placed in conductive foam during storage or handling to prevent electrostatic damage to the MOS gates.

14.3 Glossary

[SLYZ022](#) — *TI Glossary*.

This glossary lists and explains terms, acronyms, and definitions.

15 Mechanical, Packaging, and Orderable Information

The following pages include mechanical, packaging, and orderable information. This information is the most current data available for the designated devices. This data is subject to change without notice and revision of this document. For browser-based versions of this data sheet, refer to the left-hand navigation.

PACKAGING INFORMATION

Orderable Device	Status (1)	Package Type	Package Drawing	Pins	Package Qty	Eco Plan (2)	Lead/Ball Finish (6)	MSL Peak Temp (3)	Op Temp (°C)	Device Marking (4/5)	Samples
TLC5958RTQR	ACTIVE	QFN	RTQ	56	2000	Green (RoHS & no Sb/Br)	CU NIPDAU	Level-3-260C-168 HR	-40 to 85	TLC5958	Samples
TLC5958RTQT	ACTIVE	QFN	RTQ	56	250	Green (RoHS & no Sb/Br)	CU NIPDAU	Level-3-260C-168 HR	-40 to 85	TLC5958	Samples

(1) The marketing status values are defined as follows:

ACTIVE: Product device recommended for new designs.

LIFEBUY: TI has announced that the device will be discontinued, and a lifetime-buy period is in effect.

NRND: Not recommended for new designs. Device is in production to support existing customers, but TI does not recommend using this part in a new design.

PREVIEW: Device has been announced but is not in production. Samples may or may not be available.

OBSELETE: TI has discontinued the production of the device.

(2) Eco Plan - The planned eco-friendly classification: Pb-Free (RoHS), Pb-Free (RoHS Exempt), or Green (RoHS & no Sb/Br) - please check <http://www.ti.com/productcontent> for the latest availability information and additional product content details.

TBD: The Pb-Free/Green conversion plan has not been defined.

Pb-Free (RoHS): TI's terms "Lead-Free" or "Pb-Free" mean semiconductor products that are compatible with the current RoHS requirements for all 6 substances, including the requirement that lead not exceed 0.1% by weight in homogeneous materials. Where designed to be soldered at high temperatures, TI Pb-Free products are suitable for use in specified lead-free processes.

Pb-Free (RoHS Exempt): This component has a RoHS exemption for either 1) lead-based flip-chip solder bumps used between the die and package, or 2) lead-based die adhesive used between the die and leadframe. The component is otherwise considered Pb-Free (RoHS compatible) as defined above.

Green (RoHS & no Sb/Br): TI defines "Green" to mean Pb-Free (RoHS compatible), and free of Bromine (Br) and Antimony (Sb) based flame retardants (Br or Sb do not exceed 0.1% by weight in homogeneous material)

(3) MSL, Peak Temp. - The Moisture Sensitivity Level rating according to the JEDEC industry standard classifications, and peak solder temperature.

(4) There may be additional marking, which relates to the logo, the lot trace code information, or the environmental category on the device.

(5) Multiple Device Markings will be inside parentheses. Only one Device Marking contained in parentheses and separated by a "~" will appear on a device. If a line is indented then it is a continuation of the previous line and the two combined represent the entire Device Marking for that device.

(6) Lead/Ball Finish - Orderable Devices may have multiple material finish options. Finish options are separated by a vertical ruled line. Lead/Ball Finish values may wrap to two lines if the finish value exceeds the maximum column width.

Important Information and Disclaimer:The information provided on this page represents TI's knowledge and belief as of the date that it is provided. TI bases its knowledge and belief on information provided by third parties, and makes no representation or warranty as to the accuracy of such information. Efforts are underway to better integrate information from third parties. TI has taken and continues to take reasonable steps to provide representative and accurate information but may not have conducted destructive testing or chemical analysis on incoming materials and chemicals. TI and TI suppliers consider certain information to be proprietary, and thus CAS numbers and other limited information may not be available for release.

In no event shall TI's liability arising out of such information exceed the total purchase price of the TI part(s) at issue in this document sold by TI to Customer on an annual basis.

TAPE AND REEL INFORMATION



QUADRANT ASSIGNMENTS FOR PIN 1 ORIENTATION IN TAPE



*All dimensions are nominal

Device	Package Type	Package Drawing	Pins	SPQ	Reel Diameter (mm)	Reel Width W1 (mm)	A0 (mm)	B0 (mm)	K0 (mm)	P1 (mm)	W (mm)	Pin1 Quadrant
TLC5958RTQR	QFN	RTQ	56	2000	330.0	16.4	8.3	8.3	1.1	12.0	16.0	Q2
TLC5958RTQT	QFN	RTQ	56	250	180.0	16.4	8.3	8.3	1.1	12.0	16.0	Q2

TAPE AND REEL BOX DIMENSIONS

*All dimensions are nominal

Device	Package Type	Package Drawing	Pins	SPQ	Length (mm)	Width (mm)	Height (mm)
TLC5958RTQR	QFN	RTQ	56	2000	367.0	367.0	38.0
TLC5958RTQT	QFN	RTQ	56	250	210.0	185.0	35.0

IMPORTANT NOTICE

Texas Instruments Incorporated and its subsidiaries (TI) reserve the right to make corrections, enhancements, improvements and other changes to its semiconductor products and services per JESD46, latest issue, and to discontinue any product or service per JESD48, latest issue. Buyers should obtain the latest relevant information before placing orders and should verify that such information is current and complete. All semiconductor products (also referred to herein as "components") are sold subject to TI's terms and conditions of sale supplied at the time of order acknowledgment.

TI warrants performance of its components to the specifications applicable at the time of sale, in accordance with the warranty in TI's terms and conditions of sale of semiconductor products. Testing and other quality control techniques are used to the extent TI deems necessary to support this warranty. Except where mandated by applicable law, testing of all parameters of each component is not necessarily performed.

TI assumes no liability for applications assistance or the design of Buyers' products. Buyers are responsible for their products and applications using TI components. To minimize the risks associated with Buyers' products and applications, Buyers should provide adequate design and operating safeguards.

TI does not warrant or represent that any license, either express or implied, is granted under any patent right, copyright, mask work right, or other intellectual property right relating to any combination, machine, or process in which TI components or services are used. Information published by TI regarding third-party products or services does not constitute a license to use such products or services or a warranty or endorsement thereof. Use of such information may require a license from a third party under the patents or other intellectual property of the third party, or a license from TI under the patents or other intellectual property of TI.

Reproduction of significant portions of TI information in TI data books or data sheets is permissible only if reproduction is without alteration and is accompanied by all associated warranties, conditions, limitations, and notices. TI is not responsible or liable for such altered documentation. Information of third parties may be subject to additional restrictions.

Resale of TI components or services with statements different from or beyond the parameters stated by TI for that component or service voids all express and any implied warranties for the associated TI component or service and is an unfair and deceptive business practice. TI is not responsible or liable for any such statements.

Buyer acknowledges and agrees that it is solely responsible for compliance with all legal, regulatory and safety-related requirements concerning its products, and any use of TI components in its applications, notwithstanding any applications-related information or support that may be provided by TI. Buyer represents and agrees that it has all the necessary expertise to create and implement safeguards which anticipate dangerous consequences of failures, monitor failures and their consequences, lessen the likelihood of failures that might cause harm and take appropriate remedial actions. Buyer will fully indemnify TI and its representatives against any damages arising out of the use of any TI components in safety-critical applications.

In some cases, TI components may be promoted specifically to facilitate safety-related applications. With such components, TI's goal is to help enable customers to design and create their own end-product solutions that meet applicable functional safety standards and requirements. Nonetheless, such components are subject to these terms.

No TI components are authorized for use in FDA Class III (or similar life-critical medical equipment) unless authorized officers of the parties have executed a special agreement specifically governing such use.

Only those TI components which TI has specifically designated as military grade or "enhanced plastic" are designed and intended for use in military/aerospace applications or environments. Buyer acknowledges and agrees that any military or aerospace use of TI components which have **not** been so designated is solely at the Buyer's risk, and that Buyer is solely responsible for compliance with all legal and regulatory requirements in connection with such use.

TI has specifically designated certain components as meeting ISO/TS16949 requirements, mainly for automotive use. In any case of use of non-designated products, TI will not be responsible for any failure to meet ISO/TS16949.

Products

Audio	www.ti.com/audio
Amplifiers	amplifier.ti.com
Data Converters	dataconverter.ti.com
DLP® Products	www.dlp.com
DSP	dsp.ti.com
Clocks and Timers	www.ti.com/clocks
Interface	interface.ti.com
Logic	logic.ti.com
Power Mgmt	power.ti.com
Microcontrollers	microcontroller.ti.com
RFID	www.ti-rfid.com
OMAP Applications Processors	www.ti.com/omap
Wireless Connectivity	www.ti.com/wirelessconnectivity

Applications

Automotive and Transportation	www.ti.com/automotive
Communications and Telecom	www.ti.com/communications
Computers and Peripherals	www.ti.com/computers
Consumer Electronics	www.ti.com/consumer-apps
Energy and Lighting	www.ti.com/energy
Industrial	www.ti.com/industrial
Medical	www.ti.com/medical
Security	www.ti.com/security
Space, Avionics and Defense	www.ti.com/space-avionics-defense
Video and Imaging	www.ti.com/video

TI E2E Community

e2e.ti.com