

A place to catalogue analogue drum experiments, clonings, mods, hacks, bends, MIDIbox integration, specialised drum sequencers, MBSEQ firmware, SID as drum machine, triggering, E-Drum heads etc etc etc.

Related pages on this wiki and ucapps.de :

MIDIBox SEQ v2 - a simple control surface can be built with 16 LEDs/switches and one encoder (according to the SEQ Drum Mode tutorial below), and still have full access to this [amazing sequencer engine](#). Up to 48 separate MIDI drum note assignments x 16 steps.

Can also take an [AOUT module](#) for [up to four](#) CVs outs. The DOUTx4 expansion mentioned under MIDI0128 below could possibly be coded in.

With added code, a LED matrix to display all drum patterns simultaneously may also be possible, as in the [Simmons SDS6](#). Moxi has already implemented a 4x16 button/LED matrix, and TK has indicated up to 1024 may be possible (in MIOS, not necessarily in the SEQ). [4x16 LED matrix wiring](#) - **PDF**. Also see the [Sparkfun](#) parts listed below.

MIDI0128 - up to 128 on/off signals and 128 input switches from one core. Useful for a simple fixed velocity MIDI to trigger/gate converter, sequenced from other equipment or software. A user adaption has added a [DOUTx4 module](#) for another 32 fixed velocity trigger outs.

MIDIBox CV - 8 gates and 2 analog CVs per AOUT module. Could be adapted for velocity triggers?

TR Sequencer - User project page to define and re-create the classic Roland TR-x0x drum sequencer user interface

DSEQ32 - mess's 32 step 8 track drum sequencer

MIOS Downloads - Code examples for:

- * 8 CV outputs with the MBHP_AOUT module
- * button matrix of 8x8 = 64
- * 64 CV INs and OUTs
- * 64 pots, 128 buttons, 128 LEDs
- * velocity buttons (e.g. for drumpads)
- * MIDIBox SID - steal matrix code
- * MIDIBox SEQ

Forum topics:

[MIDIBox SEQ Drum Mode](#)

[MIDIBoxSID as drum machine](#) - sounds like [this!](#)

[Analog drum modules](#) - cloning and triggering them - the thread that started it all

[Moogah's 808/909 clone](#)

[Beginner's 16 step SEQ project](#)

[Alternative sequencer firmware](#)

[MB SEQ with button matrix?](#)

[SEQ with 4x16 buttons and LEDs](#)

[16x16 button matrix](#)

[4x16 LED/button matrix](#)

[using scan matrix together with led matrix?](#) - Success!

[MB-SEQ LED-Matrix in Firmware aktivieren](#) - auf Deutch or [in Google English](#)

[Diode matrix input](#) - large matrix with MIDIO128

[80 LEDs from one CORE](#)

Other resources

[V-Trig, S-Trig and Gate](#) - from Wikipedia

[Gates and Triggers, Mystery Solved](#) - from synthesizers.com

[PIC MIDI programming](#) - getting started

[Drum pads and EDrums](#)

[A good piezo pad design](#)

[EDrum For Free](#) - great DIY site, heaps of designs for pads, triggers, pedals, hats etc

[Yahoo Groups](#)

[TR-707](#) - Service manual, schematics, mods: you'll need to join to access files.

[Drummachine](#) - moderator approval to join

[Roland Drum Machines](#)

[rolandtr505](#)

[Simmons_Drums](#) - schematics and service manuals galore

[Circuit Bending](#) - just a list of search results

Useful Parts

[RGB Matrix](#)

[Sparkfun Electronics](#) have an [8x8 RGB LED Matrix](#) with an SPI serial controller attached for \$59.95. Red/Green version \$34.95, matrix only small \$4.95 large \$29.95.

The serial controller backpack contains a reprogrammable AVR ATmega8 microcontroller, which bumps up the value equation and opens a world of possibilities, such as LED sensors.

[4x4 lighted key matrix](#)

According to [this forum thread](#), [Sparkfun](#) will also soon be offering "silicone illuminated buttons ... 4x4 arrays that will cost between \$20 and \$30 U.S ... with 5mm holes for our tri-color LEDs."

[High power shift register](#)

[Shift register 8 bit high power](#) - serial in, 8 pins out at up to 50V/150mA each. \$1.95. Sparkfun again :) This would be handy for triggering modules that expect more than +5V as from a DOUT.

Schematics:

[S-Trig to V-Trig converter](#) - also see below. 505/707 internal triggers are S-Trig.

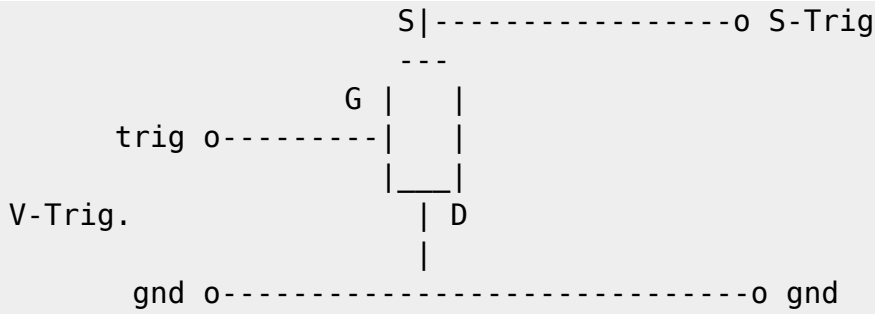

where G, S, and D stand for Gate, Source and Drain - and I may have them mixed up, coz I'm doing this from a bad memory)

To do:

- * MBFM drums (duh)
- * Jamaroonies
- * 505/707 as trigger source
- * LED matrix

From: <https://www.midibox.org/dokuwiki/> - **MIDIbox**

Permanent link: <https://www.midibox.org/dokuwiki/doku.php?id=drumstuff&rev=1160904901>

Last update: **2007/04/02 15:40**

