

MIDIBox AY 3 8912 Mixer

- OP AMP Mixer (Tone ABC) for the MIDIBox AY 3 8912 (Ver. 1a)

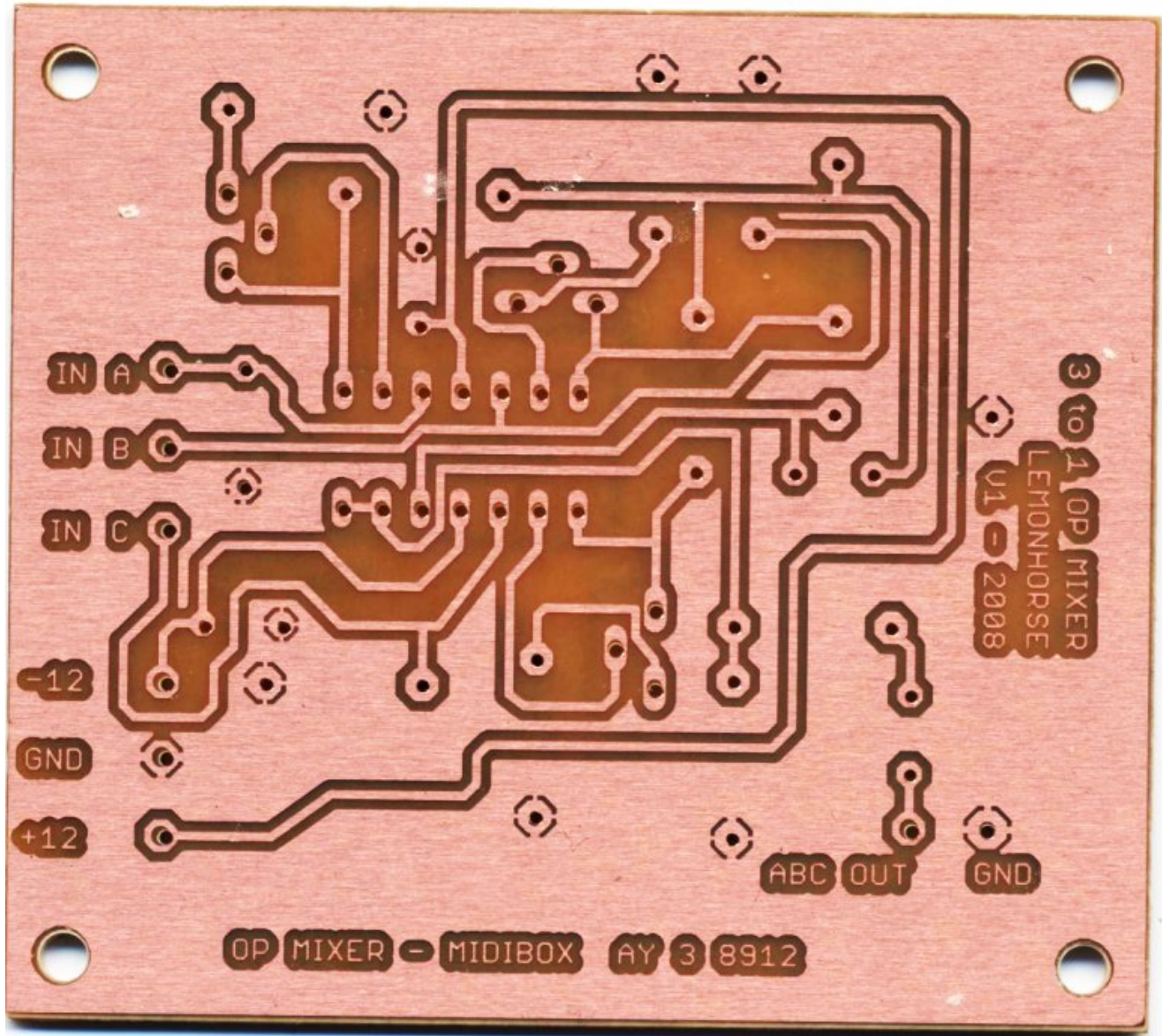

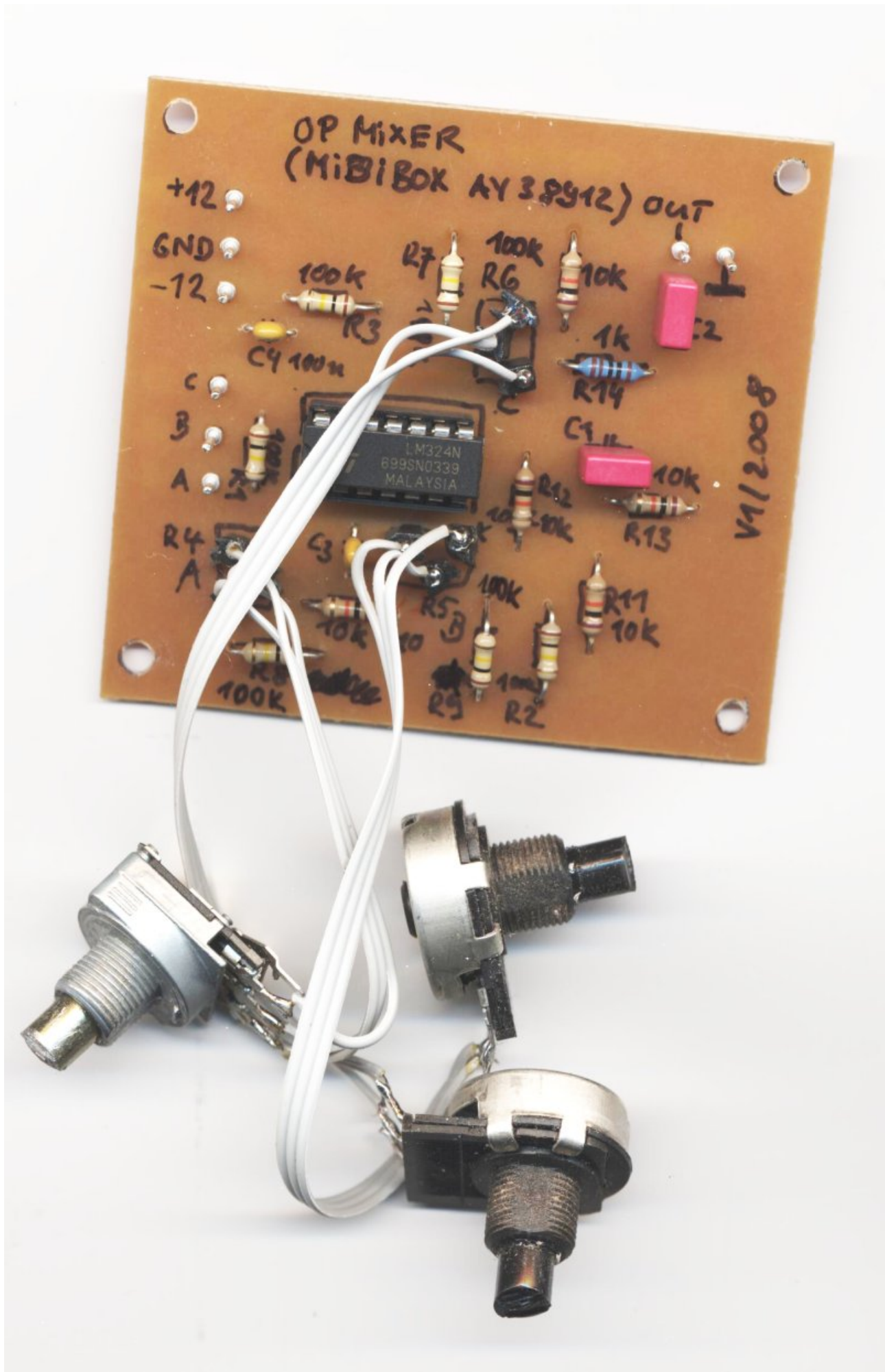



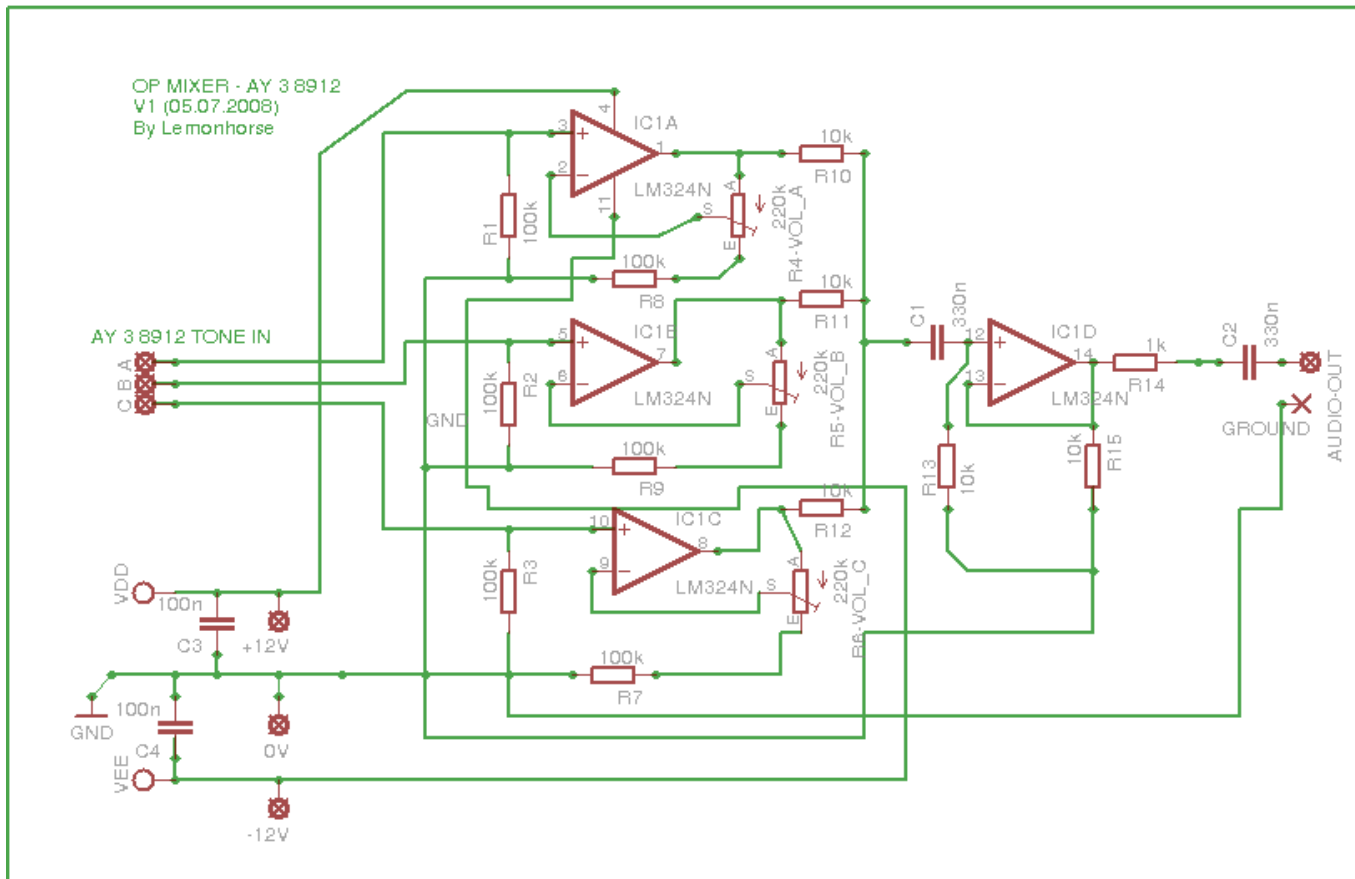

Notes:

- Pot R4 (Volume Tone A), R5 (Volume Tone B) and R6 (Volume Tone C) are designed for volume finetuning (not for turning off tone A/B/C)

Pot Options:

- R4, R5, R6 = 100k (less volume)
- R4, R5, R6 = 220k (more volume)

OP: LM324N (4xOP, +/-12V) - Datasheet:

- => [LM324N.pdf](#) /
- => [lm324.pdf](#)

Download: Eagle 5.1 Files + Partlist - MIDIBox AY 3 8912 Mixer (Ver.1a)

[mbay_eagle.zip](#)

⋮ ⋮ ⋮

MASTER VOLUME POT

MASTER VOLUME POT

MIDIBOX AY 3 8912

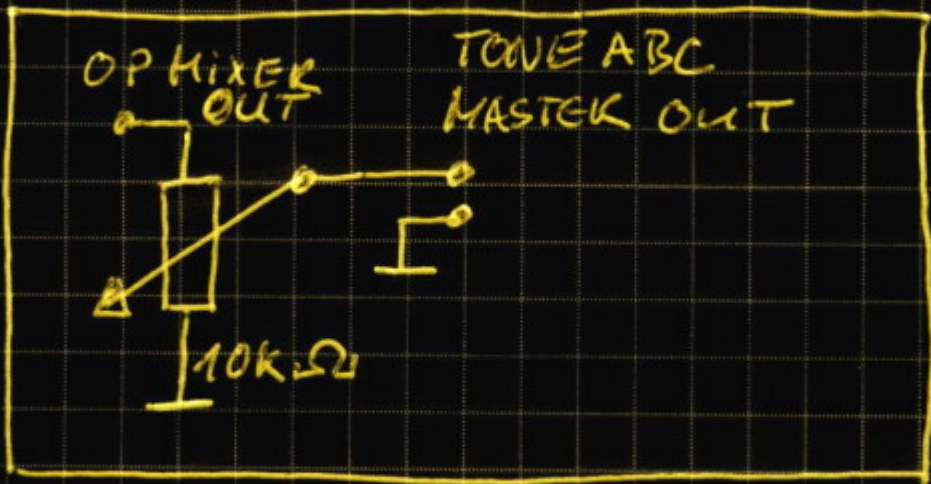
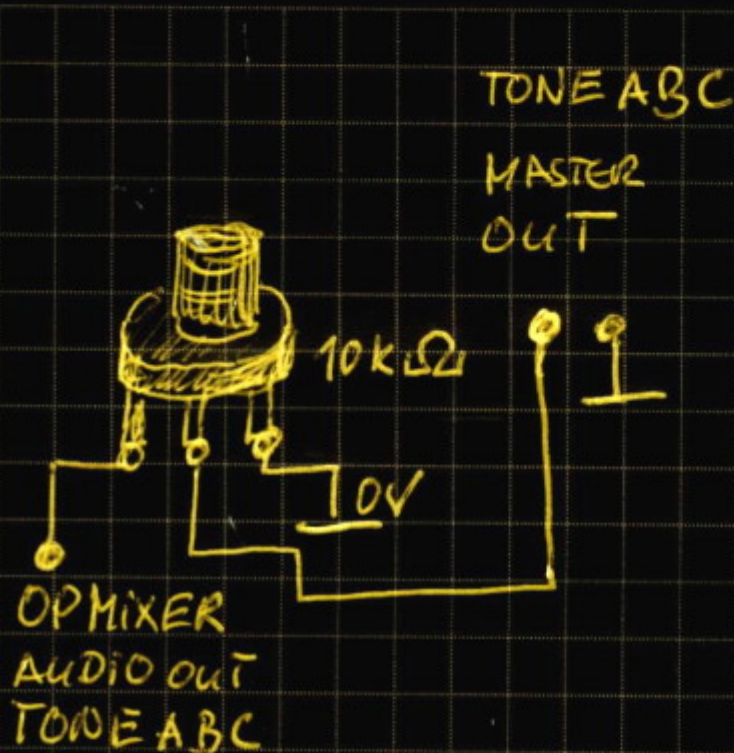

Lemouhose
07.09.2008

.....

