

Power Supplies

Find Here some schematics for DIY Power Supplies. It could help to power your midibox !

! Be Aware of high voltages! - Stay Safe !

+5V DC / +9V DC / +12V DC



5V-9V-12V DC Regulated Power Supply - Current output : 1A

5V Parts List

Value	Type	Qty	Designation
LM7805	VR	1	U1
1N4007	Diode	4	D1,D2,D3,D4
220	Resistor	1	R1
22µF/25V	Capa Elec	1	C2
2200µF/40V	Capa Elec	1	C1
9VDC 15VA	Transfo	1	TR

9V Option

Replace:

- U1 > LM7809
- TR out> 12VDC
- R1 > 390ohms

12V Option

Replace:

- U1 > LM7812
- TR out> 12VDC
- R1 > 510ohms

-12V/+12V DC

A designed has been purposed [There](#)

-15V/+15V DC

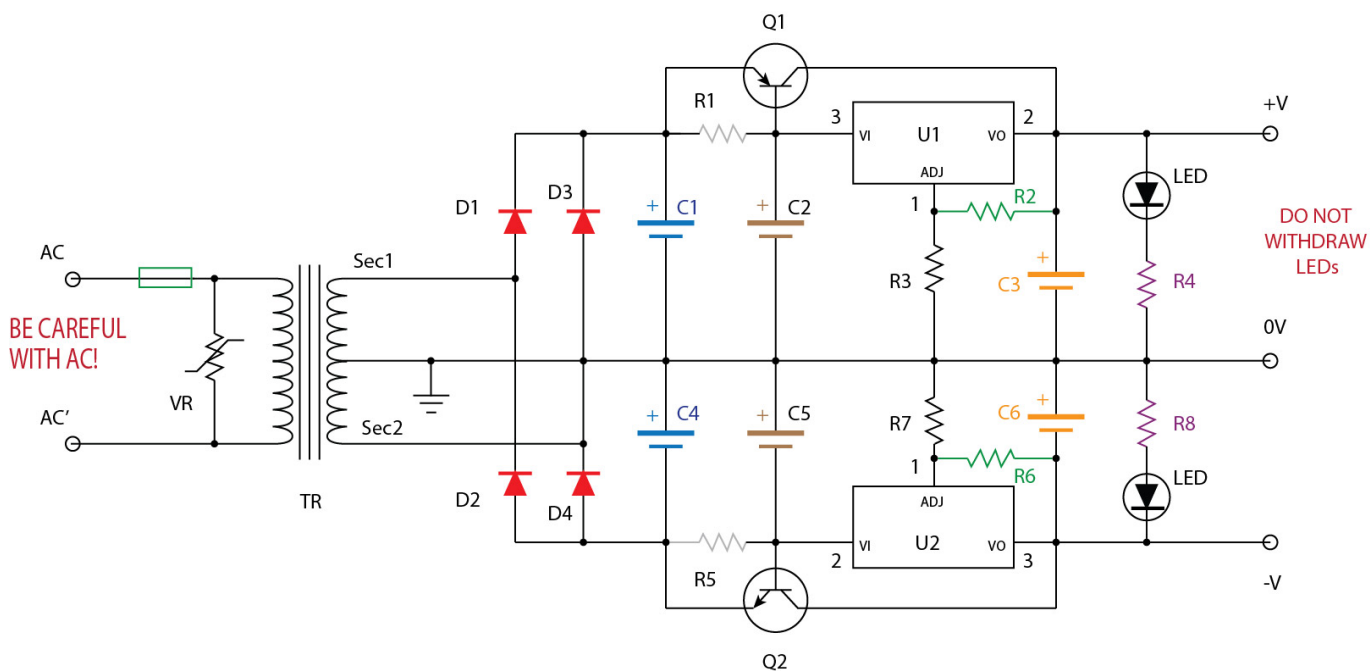

+15/-15V Bipolar Regulated Power Supply - Current output : 4A

Parts List

Value	Type	Qty	Designation
LM317T	VR	1	U1
LM337T	VR	1	U2
BDX54	PNP	1	Q1
BDX53	NPN	1	Q2
10A04	Diode	4	D1,D2,D3,D4
10	Resistor	2	R1,R5
120	Resistor	2	R2,R6
820	Resistor	2	R4,R8
1320(1,1k+220)	Resistor	2	R3,R7
1µF/25V	Capa Elec	2	C2,C5
22µF/25V	Capa Elec	2	C3,C6
10000µF/40V	Capa Elec	2	C1,C4

Value	Type	Qty	Designation
S05K400	Varistor	1	VR
15VDCx2 90VA	Transfo	1	TR

For Fine Voltage Tuning replace R3/R7 by a 2K Multi turns Trimpot.

Forum Threads

- [Compact PSU by Altitude](#)

From:

<https://www.midibox.org/dokuwiki/> - **MIDIbox**

Permanent link:

https://www.midibox.org/dokuwiki/doku.php?id=power_supplies&rev=1465982519

Last update: **2016/06/15 09:21**

